

*International Edition*

Free,  
electronic magazine  
for railroad enthusiasts  
in the scale 1:220  
and Prototype

[www.trainini.eu](http://www.trainini.eu)

Published monthly  
no guarantee

ISSN 2512-8035

# Trainini

German Magazine for Z Gauge



**Beginner's Layout finally in Sight**

**Magical Vacuum Dust Fairy  
Optimised with little Effort**

## Introduction

Dear Readers,

This March edition of **Trainini®** is another packed and interesting edition for you - I'm pretty sure of it!

This month, for the first time, I'm taking the opportunity to write an introduction. Writing a text is quite different from creating a video feature for **Trainini TV**. So, it is with great respect that I begin by addressing my words to you now.



Ralf Junius  
Editor

Today, we are starting with the first article of our 2024/25 annual focus topic: "The path to the first layout" and it should benefit as many people as possible: Many of us keep seeing beautiful layouts at exhibitions and in articles in various trade magazines. Then the question inevitably comes to mind: Can I build something like that? As the saying goes, the sky is the limit!

And I can only confirm that. Over the past few years, my editorial colleague Dirk Kuhlmann has repeatedly reported on the construction of his segments, compact layouts, and dioramas. And now I would like to recognise myself as a great fan of his work. I particularly like the many details. I was able to pick up so many tips and tricks from the articles and then finally dared to build my first "Kistrath" display case myself.

During my visit to this year's Faszination Modellbahn in Mannheim, there was a layout competition. Unfortunately, no 1:220 scale layout took part, which I regret. Perhaps someone from our readership will be motivated and "empowered" by the new series of articles to build their first layout. And who knows what talent lies within you? Take the plunge and then show the results to the public.

My first work, which I was allowed to present in **Trainini®** 1/2020, will probably be on display in Altenbeken at the beginning of May. Everyone will then be able to see for himself how something presentable can be created in our gauge with simple means. You just must dare...

But prior to the big Z gauge weekend in Altenbeken on May 4 and 5, Intermodellbau is just around the corner in Dortmund from April 18 to 21. At the Spielwarenmesse in Nürnberg (Nuremberg) (International Toy Fair), Dr Rainer Noch and our editor-in-chief Holger Späing agreed to talk about new proposals for future 1:220 scale car models. There is still some time before this date, so the question is: Do you still have any suggestions? An interim report can be found in the news section of this edition.

And how many of you have already been to the cinemas to see the movie about the creation of Miniatur-Wunderland and its success story? We have also managed to include a small insight into the movie for you this month.

Enough said, I hope you have a great time with this edition of **Trainini®**!

Sin-Z-erely,

Ralf Junius

## Editorial

Introduction ..... 2

## Model

Small tender, big Ears ..... 4

## Prototype

Currently no items

## Design

It all starts with a Dream ..... 14

## Technology

Dusting up! ..... 26

## Literature (not translated - only in German)

When Children's Dreams come true..... 36

From a two-axle to a four-axle Vehicle..... 38

## News

On a Day Trip to Mannheim ..... 40

Zetties and Trainini in Dialogue..... 47

Imprint ..... 57

We thank Eisenbahnstiftung for their support with historical photographs.

Date of publication of the German language version of this issue: 31 March 2023

### Cover photo:

This issue starts with the construction of our beginner's layout. The project should remain manageable, lead quickly to the goal and provide valuable experience. The class 361 shunting locomotive is already on a big test run with the Küpper anniversary wagon.

03 240 at full speed

## Small Tender, big Ears

*In Trainini® 9/2023, we presented a tender construction project that resulted from a body designed by NoBa-Modelle. With an adapted chassis, it has been providing new variety on our layout ever since. The designer was enthusiastic about our idea and has now added a matching chassis with movable bogies. We have, therefore, breathed even more life into our model today with two further refinements.*

The class 03 light express locomotive was born out of necessity. Its big sister, the famous 01, had long been the DRG's first standardised steam locomotive for express train services, but many routes could not cope with its high axle load.

As the chronically cash-strapped Reichsbahn was unable to keep up with the expansion of the lines, a different solution had to be found: slimming down was now the order of the day. The running gear was given a lighter and less powerful boiler, but thanks to a largely identical running gear, it was able to maintain the required top speed of its big sister.



In April 1938, Carl Bellingrodt photographed the 03 240 (Osnabrück Hbf depot) with D 93 to Altona Hbf in Wuppertal-Unterbarmen near his home at Siegesstraße 94. The locomotive can be seen here with a tender 2'2' T 32 of the later 1926 design. Photo: RVM-Filmstelle Berlin (Bellingrodt), Eisenbahnstiftung.

Together, this combination resulted in a successful model, as the lighter 03 series, with 269 units, would eventually surpass the 01: The latter only managed 231 units, which were joined by the ten earlier zero-two units after a rebuild.

The Lightweight was not overly popular in heavy services, as a lack of steam accompanied it in its early years of service. It was not until after the Second World War that DB's optimisation of the induced draught system and use in more appropriate, lighter services resulted in a completely different picture.

The term "saloon steamer" gives the impression of travelling on a sofa, and it was actually coined by the staff who operated it. In fact, the smaller boiler was less coal-hungry and the express steam locomotive rarely ran at its performance limit, especially as it was forced out of high-quality services early on.

However, today we would like to look back at its early heyday on the German Federal Railway. It still had big ears, as the Wagner wind deflectors were sometimes called. Märklin's model has shown a three-light headlamp since 1972, which determines the period of use to around the end of the 1950s.



When 03 240 replenished her water supplies during a seven-minute stopover in Osnabrück on 17 May 1952, she had long been part of the Deutsche Bundesbahn's fleet and had already lost her smokebox central shutter. If you look closely, you can see that it now has a 2'2' T 32 tender of the 1925 design attached to it. The front water inlets used here are unusual for this tender. Incidentally, it was hauled by the F 4 "Mercur" on an unscheduled basis that day. Photo: Carl Bellingrodt, Eisenbahnstiftung

And since very successful passenger coaches for this era have recently been delivered again, the selected model (item no. 88855) is also highly topical again. It was produced soon after the 01 series was released, with which detailed control was introduced in Göttingen in 2012.

Märklin's oldest steam locomotive design also benefited from this progress in order to please not only the Insider Club members with this innovation, but also to maintain exclusivity. It was a stroke of luck for us, because this hastily procured model was a grateful photo subject.

The only thing that dampened our enthusiasm was the tender, which has also been dragged through the programme since 1972. It did not match many standard locomotives in the chosen lettering and after repairs to the injection moulds, it has long since ceased to inspire us either.

In our case, the seller also pointed out that the box contained a tender that was correct in shape but incorrectly labelled. That shouldn't stop us, because with a new locomotive labelling this is quickly rectified and it also offered the opportunity to attach a different tender.

NoBa-Modelle had sent us the upper part of the body, and the matching running gear was already under the supplied tender. We quickly found the right locomotive number for our project with 03 240, one of the youngest locomotives that was still running with a 2'2' T 32 (albeit, a newer design), at least in 1952.

While we described the customisation work for the tender in **Trainini®**, today we will briefly discuss the subsequent work on the locomotive, which will also take it a step forward. At the same time, our idea was also well provided to NoBa-Modelle, which will soon result in a new model with two variants. From then on, every Zettie will be able to convert their steam locomotive in this way.

## More variety

When we published the report on our tender conversion, our basic model (Märklin 88855) still bore its factory markings as 03 140. Externally, the condition matched the chosen prototype well. The 03 240 had a very similar number, but came from a later construction lot.

Its prototype was based at Osnabrück Hbf depot during the period in question and was also running with Wagner wind deflectors in the 1952 operating year. It also still had the smokebox central shutter, which Märklin had reproduced on the model from the beginning, in the first post-war years. The third headlight once had a different meaning, but can also be explained on the model.



This is what our model looked like at the end of our first report. The locomotive can also be improved with a few more details, which are the subject of today's report. And at the end, the tender can even be swapped again.

Although the tender design is almost, but not quite, exactly the same, the superstructure of NoBa models has one decisive feature in common with that of 03 240, which was not part of the standard equipment: it also had front water inlets, as proven by several Bellingrodt photos.

That's why it seemed to us to be the perfect prototype for the model, especially as the original must have visited the Emsland route more often, and this is a declared "hobbyhorse" of at least one member of the editorial team.

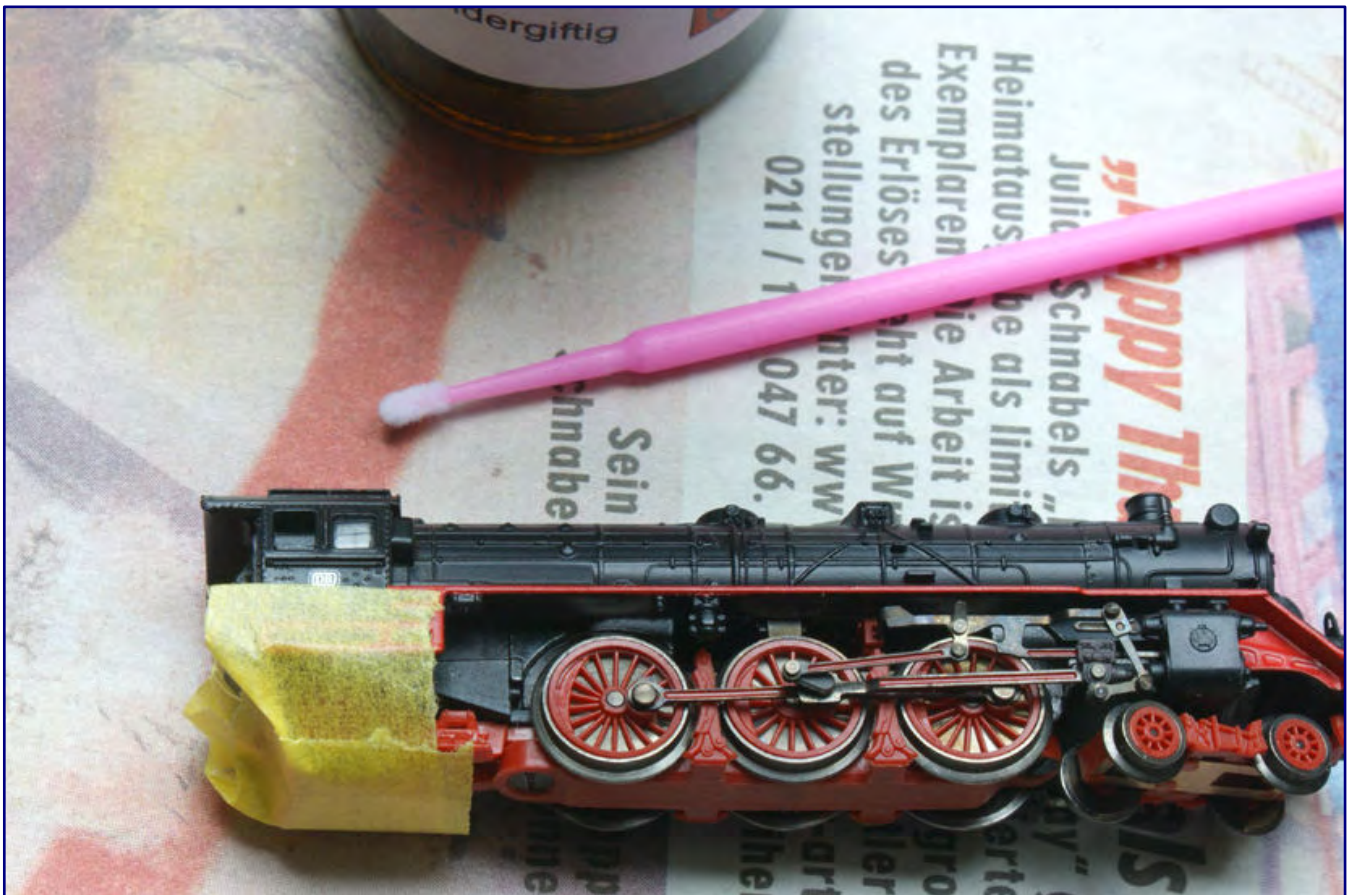

Before the new etched signs can be attached, the Ege biscuit must first be removed from the model, as the prototype had a narrower but wider sign with the lettering "Deutsche Bundesbahn".

So far, so good. In the meantime, the steam locomotive specialist Bahls Modelleisenbahnen produced the appropriate decals for the necessary re-labelling. This gave us the certainty that the font, size and material would be right to correctly reproduce the impression of the prototype signs.

Incidentally, in 1952 the Bundesbahn did not yet have its own logo and the Ege biscuit had not yet yet been designed. This is why the 03 240, which was classed as a high-quality locomotive and was still a long way from being ready for retirement, had ownership plates written on the side walls of the driver's cab. These are also special features that we certainly don't need to explain to Michael Bahls.

The old lettering could be removed with pad printing remover (unfortunately, no longer available), alternatively we recommend an electric eraser, and the etched labels were held in place with the help of a contact glue stick from Uhu (unfortunately, no longer available).

Björn Plutka drew our attention to one of his offers in good time: He has matching 3D-printed dome covers on offer to cover the housing screw shown above and also to improve the top view of the model a little more.

And so, our 03 240 also received this accessory (included in item no. ZD-220-20001-X) from Z-Doktor Modellbau. And this supplier also produced the white wet-slide decals for the locomotive after the lettering content had been reconstructed using prototype data and photographs.



The dome covers from Z-Doktor Modellbau are a visual gain when looking at the model, thanks to which the observer is spared a look at the housing screw. And the Bahls' plates for the new locomotive number are already waiting to be attached.

Our customised express locomotive now appeared almost perfect. The manufacturer of the tender body had obviously not missed out on this. The part used for our conversion had its origins in the Ardelt crane train from NoBa-Modelle, but did not photo the model that was ultimately chosen.

This is precisely why this design has not been used in the in-house programme to date, which Norbert Heller wanted to change. So why not redesign the matching chassis and offer a swap tender directly to all interested parties?

At his request, our model went on a journey a few months ago in order to personally inspect the result and compare it with prototype drawings. At the same time, we weighed up whether to use a rigid bogie like Märklin's or functioning bogies.

continues on page 11



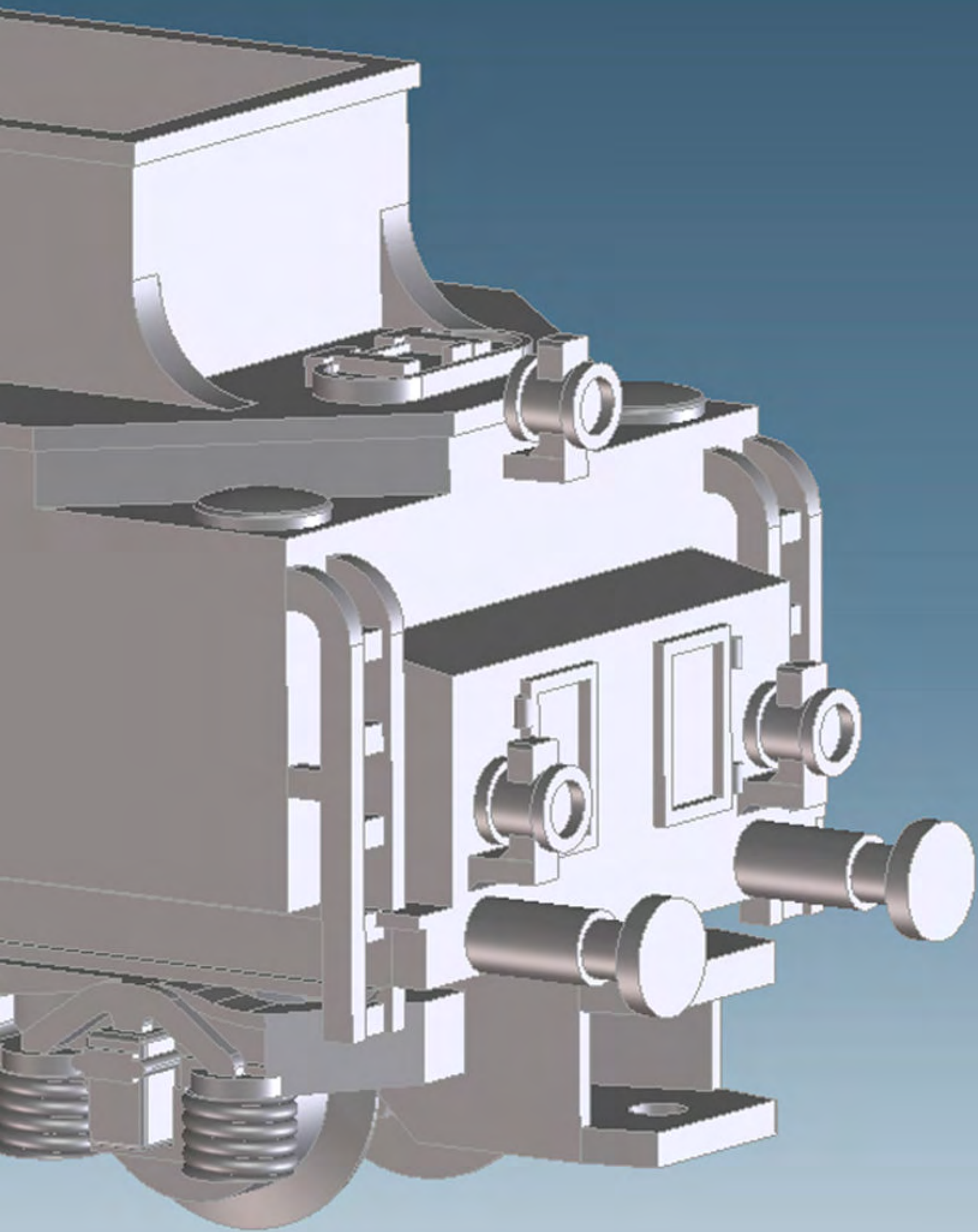



03 240 presents its new 2'2' T 32 tender from NoBa-Modelle before being trimmed, painted and labelled (photo above). This is how the soon to be purchased blank is presented to interested customers. The view of the smokebox with the new locomotive number set by steam locomotive specialist Michael Bahls shows how good the effect of etched signs is.

CAD illustration on page 9:

For the 03 series, NoBa-Modelle has created the tender version with electric lighting, recognisable by the third lantern that can be removed if required, but a version with a gas tank is also available. Illustration: NoBa-Modelle

The choice fell on bogies and thus a solution such as Märklin had used for the class 10 itself. Attachment to the locomotive is carried out in the same way, the rear of the tender offers the customer a standard coupling.

The plug-in boards of the upper section, which were still missing from our sample assembly, were also added. We still recommend using real coal for the contents of the coal box, as its effect is unsurpassable. A further modification will also soon be realised on our model.



After all the work has been completed, our 03 240 goes on a long journey with the new Märklin compartment cars and enhances the layout with a new tender variant.

The DRG drawings for the 2'2' T 32 tender still show a gas tank for the locomotive lighting on the rear side, resting on the tool box. However, this was not (or no longer) installed on the class 03, as electric lighting had been subsequently introduced.

NoBa-Modelle wants to offer this older version for other models, which can be restored to an earlier state in accordance with Era II. For the DB version of the 03 series with a turbo generator next to the chimney, however, the gas tank is also omitted in the model.

Just above its previous position, customers will then find a third headlight in the form of an attached lantern, which matches both later versions after 1958 and the condition of the Märklin base model shown.

This means that the conversion shown by us will soon no longer be necessary. The necessary parts can then be ordered as a blank with an inscription set or (probably) as a finished model to match the target model.

At the time of going to press, the item number for the tender was not yet available. Although it will soon be included in the programme, we cannot, yet, reliably say whether this new product will be available before the summer break.

However, if you would like to add a little more individuality to your steam locomotive stock, you should definitely make a note of this offer.

**Basic model for our refinement:**

<https://www.maerklin.de>

**Supplier for the exchange and super parts:**

<http://www.bahls-modelleisenbahnen.de>

<https://www.noba-modelle.de>

<https://www.z-doktor.de>

---

## Easter greetings



The editorial team wishes all readers a happy Easter and relaxing holidays!

---

# *Ihre Film- und Fotosammlung braucht einen sicheren Hort!*

## **Unsere Aufgaben:**

### Film-/Fotosammlungen:

- **bewahren**
- **auswerten**
- **veröffentlichen**

### Eisenbahnprojekte:

- **fördern**
- **initiiieren**

## **Unsere Garantien:**

- + **personenunabhängig**
- + **sicher**
- + **gemeinnützig**
- + **steuerlich privilegiert**

*Sie möchten  
eine Sammlung der  
Nachwelt erhalten?*

**0151/573 96 21 1**  
Rufen Sie uns einfach an!

*Sie möchten unsere  
Arbeit unterstützen?*

**Bilderkonto:**  
Stadtparkasse Solingen  
DE73 3425 0000 0001 3362 47

EISENBAHNSTIFTUNG

JOACHIM SCHMIDT



[www.eisenbahnstiftung.de](http://www.eisenbahnstiftung.de)

## The path to the first layout (Part 1) **It all starts with a Dream**

*Anyone who gets into the model railway hobby usually dreams of having their own layout on which the newly acquired vehicles can complete their laps and bring joy to their operator. But the way there needs to be considered, even if it doesn't have to be difficult. Our new series is intended to help you orientate yourself and realise your own wishes.*

Our new annual focus topic 2024/25 kicks off today and with this article. We would like to address newcomers to Z gauge, in particular, and help them to successfully realise their desires for their first layout.

There are always several ways to reach a goal and this is exactly what this series of articles aims to emphasise. This fact also provides the reason why this thematic focus is planned for the first time over two years: As part of the series of contributions, two layouts are to be created that are as different, as possible, and thus address different aspects and requirements.



Our new beginners' series is designed to help you have fun quickly. The first of the two projects dealt with is dedicated to the much too often neglected topic of winter and is realised with the ballast track from Rokuhan.

One will take up a summer theme and be realised with Märklin material. Dirk Kuhlmann will be responsible for this and will tackle the construction together with new Zetties. The aim is to practise the art of layout construction as comprehensively as possible, also from a technical point of view.

The second layout we are starting with today takes a completely different approach: The basis is a prefabricated layout from Noch, which is to be fitted with ballasted tracks from Rokuhan. We have chosen

“St. Anton” (item no. 87015), a winter landscape in contrast to the second proposal, which will take shape at the same time.

The selected prefabricated terrain is made of textured hard foam and is painted. It contrasts pleasantly with the appearance of the deep-drawn layouts that were once exclusively used, as the rocks here also have prototypically angular structures and considerably surpass their historical predecessors in appearance.

If you want, you can quickly cover such a prefabricated site with track, connect them, insert buildings in the designated places to begin operations, and consider your first layout complete. But, that would be too easy for us.



If you want to own a ready-to-run layout quickly or even consider yourself to be less talented as a craftsman, the quickest and safest way to achieve your goal is with a prefabricated layout. We demonstrate this with “St. Anton” (item no. 87015) from Noch, prefabricated in PU hard foam and supplied with instructions, matching bridge parts, and a tunnel floor base.

We would like to use the good preparatory work that Noch does here ex-works to preserve the appearance in the areas that are to be individually added and to embed it in the overall scene. After all, the winter landscape is already hand-coloured in white and conveys freshly fallen snow that is still a far from melting away.

Roofs with no snow cover at all, open roads that show no signs of snow clearance, or even a railway track bed where not a single snowflake has settled cannot have a credible effect on the viewer. And the figures that will later bring life here should also be dressed appropriately for the time of year.

Hopefully, it is already clear at this point that every layout, whether freely planned or designed according to a template, requires a plan. This is the result of an idea that stems from the desire to have a separate outlet for rolling stock.

## Small, but mighty

At least one theme must always be planned, an operating concept derived from this, a sensible track plan, and then the appropriate design items. Much of this is already predefined by the manufacturer because it is a prefabricated site. Individuality is therefore limited to designing according to your own ideas.

With edge dimensions of 53.5 x 40.5 cm, this is a very compact arrangement, which naturally does not leave much room for a large number of themes. Accordingly, Noch has specified a rural low mountain range motif, which envisages a small village or even just part of a village on a single-track branch line.

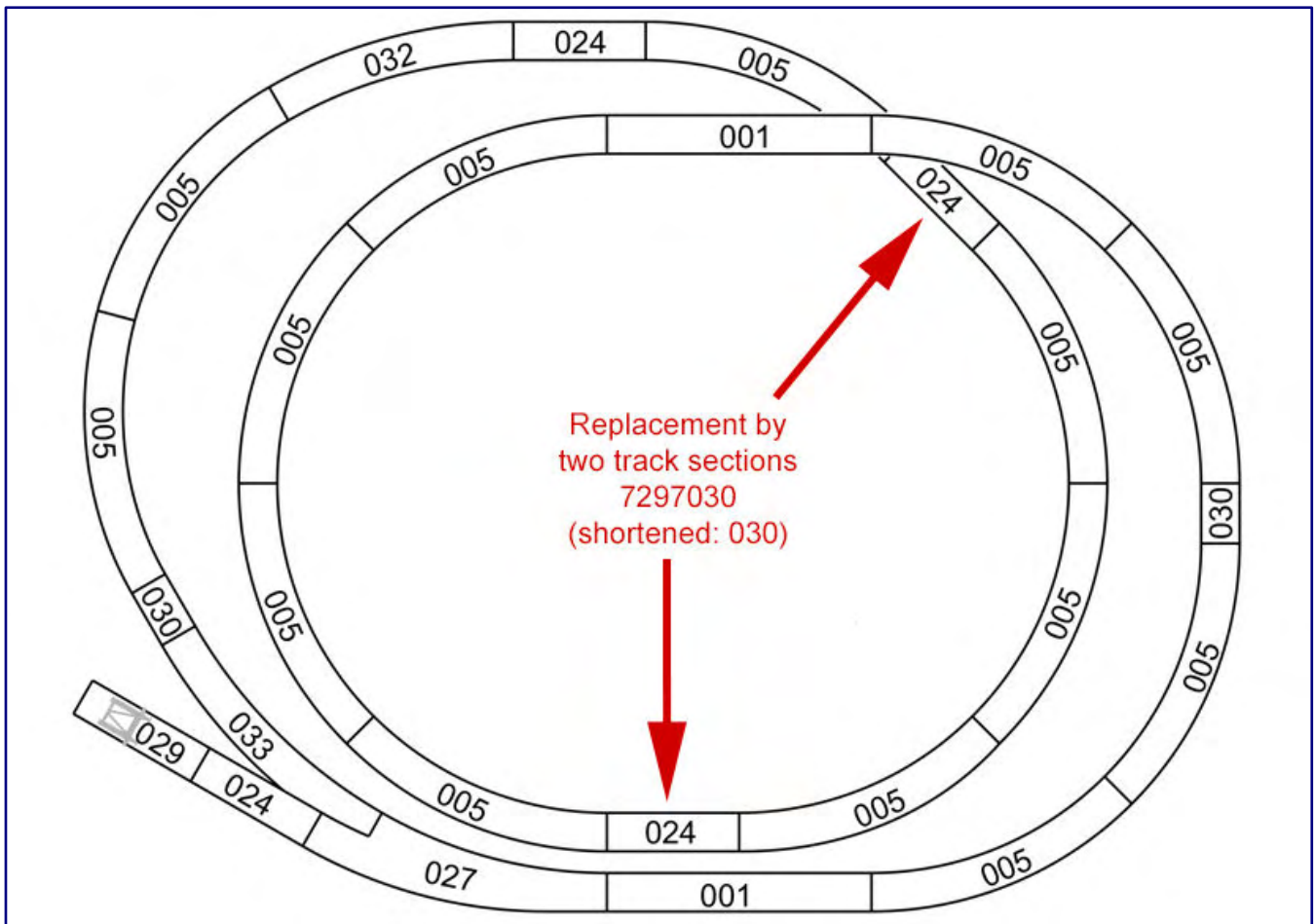

A track plan and the operating concept are already provided by Noch. However, the Rokuhan track plan reproduced here (as of May 2018) contains errors compared to that for the Märklin track, so the two marked ones should definitely be shortened. Track plan: Noch

There is even no need for a track plan in this case, because a track figure is fixed and cannot be changed. It was firmly planned by Noch, when the PU rigid foam part was designed in Wangen (Allgäu). Due to the tight radii, the supplier recommends not using coaches longer than 8.5 cm. This would not look good in the curves, but could also cause operational problems, if swivelling vehicle parts were to hit portals, bridges, or rocks.

The operating concept can be described in a single sentence: Round trips on an intertwined figure of eight with a single, short train set. The short siding is suitable at most for a two-axle goods wagon or a very short locomotive such as the V 60 or a Köf. As no points movements are possible, there are no shunting movements, and the track stub at the buffer stop is more of a decorative feature.



If you want to divide the rather short track section into blocks, you could possibly run two trains one behind the other. This would result in alternating train encounters on the two station tracks, but the traffic would not run smoothly either.

Noch's scope of delivery includes a bridge for the visible area, which spans a valley opening through which both the village road and the route of the inner circle run, as well as a cover plate to be glued into place for the tunnel section. The bridge consists of a straight ramp section (8976) and a sawn-off, curved ramp section (8977) from Märklin.



As the Rokuhan track material is only offered in fixed packaging units (PU), the model railway enthusiast will definitely retain some track pieces. Our compilation shows the purchase according to the Noch list: Only item 7297032, which is supplied with the curved turnout, has been omitted. Its shortened embankment cannot be seen in the tunnel anyway. The correction of the track plan, which also results in changes to the parts list, has not yet been taken into account at this point in the preparations!

The list of suggestions for buildings and accessories is also interesting: as you would expect, the specialist from Allgäu recommends its own design materials, and also its own figures. However, the tip on Faller and Vollmer kits is astonishing, as the company's own hard cardboard kits on identical layouts have long since made it independent of third-party ranges.

We will deliberately deviate from the tips here and use the contemporary Noch buildings, but will also take other suppliers into account when designing further. As already mentioned at the beginning, we have decided in favour of Rokuhan for the track material in this case.

As this manufacturer has followed the Märklin track geometry, there would be identical pieces of track with different numbers to choose from. However, the Rokuhan track plan contains some differences, as two 25 mm elements (Märklin) have been replaced several times by a 55 mm track section (Rokuhan).

**Good advice for beginners**  
 If you want to tackle your first construction project, you are well advised to "bake small rolls" first. Even if your head is full of wishes for many operating options and plenty of functional accessories to be used, there is a cardinal error lurking here.  
 Limiting yourself to a smaller system or an operating diorama with a manageable amount of time prevents frustration because the first operating experience is not too long in coming.  
 In addition, it is not only completed more quickly, but also allows you to gain important experience in order to avoid basic beginner's mistakes in a large follow-up project.

We had to change this in two places in order to save the 5 mm excess length.

However, while Märklin tracks can be bought individually, the Japanese alternative only offers a choice of pre-packaged packs. This means that there are always pieces of track left over that can only be used in future projects.

Below we list the article numbers for the track (after the above-mentioned correction) and the required quantity.

It must then be compared with the respective packaging unit (PU) in order to acquire the required number of pieces, unless there are leftover pieces in your own stock, or they can be exchanged with model railway colleagues:

<u>Item no.</u>	<u>Description</u>	<u>No. of Pieces</u>	<u>No. of PU</u>
7297001	Straight track, 110 mm, with connection panel (4 pcs.)	2	1
7297005	Track curved R145-45° (4 pcs.)	14	4
7297024	Straight track, 55 mm, with connection panel (2 pcs.)	2	1
7297027	Curved turnout, right R220/195-30° (1 pc.)	1	1
7297029	European buffer stop, 42 mm (2 pcs.)	1	1
7297030	Straight track, 25 mm (4 pcs.)	6	2
7297032	Curved track R195-30° (6 pcs.)	1	0*
7297033	Curved track R220-30° (6 pcs.)	1	1

\* The marked track section is required in a single quantity and is already included with the curved turnout as a levelling section (cut at the ballast); it does not need to be procured separately here.

For regulating train operation and switching the light in buildings, Noch recommends its own electronic controller kit (88163), which is manufactured to fit perfectly. It can be operated with a mains connection, or powered by a 9-volt block battery.

Its instructions also contain a description of how to install it. In conjunction with the separately available plug-in power supply unit (88171), this provides an ideal solution for a suitcase layout, as this is exactly what the prefabricated terrain we use is actually intended.

However, we are thinking of finding a different presentation and installation method, which we will not describe in detail today. In view of the planned use, the in-house controller has also been ruled out and we will have to think more about connection sockets at the installation points.

## Test laying of the track

Before the first track laying test can occur, the supplied bridge must be inserted, aligned, and fixed in place with the hot glue gun according to the manufacturer's instructions. We attached it with track screws and did a good job, as we will see in a moment.

The individual track sections can then be gradually assembled according to the track plan in the instructions and laid out loosely on the layout. This is the only way to ensure that the specified routes match the track sections and to rule out errors due to incorrect swapping.



The one and a half ramp pieces included as bridge parts are from Märklin and have been designed for their track system. We first have to cut off the clamps for its sleeper strip for covering with Rokuhan bed tracks. The bridge is then painted completely in medium grey.

An error constellation actually comes to light in this step, which is not due to a swap, but is caused by an error in the track plan. We were able to correct this by replacing two pieces of track 7297024 (55 mm) with four pieces of track 7297030 (25 mm).

There is another point in the plan where the Märklin track plan has a 50 mm track length and the Rokuhan plan has 55 mm, but joining the tracks together does not result in any further tensions or even gaps.

The track figure is now correct and lies flat on the base of the layout as soon as the clamps for the Märklin track on the ramp sections are broken off with a pair of tweezers, because the ballast track is wider and rests on them.

The following extensive test runs will now check that the locomotive and wagons do not hit any rocks or the tunnel portals. Everything looks good for the most part, a railbus (Märklin 8831) runs its rounds without any problems and is the typical vehicle for the route shown here.

continues on page 21



The test runs show a need for adaptation: While a rail bus (photo below) passes through the track figure without any problems, the bridge clearance is not sufficient for the 361 series (photo above) and many other vehicle models. The bridge, therefore, has to be raised slightly, but this proves to be no problem.

But, of course, we also extend the tests to other, short rolling stock. Unfortunately, there are problems with a Rokuhan "Glass Train" shorty, as well as with a class 361 diesel shunting locomotive (Märklin 88641): Unfortunately, the height of the bridge passage is not sufficient for both.

The reason for this is the bedding of the Rokuhan track, which was not taken into account when this part was originally designed for Märklin parts. Consequently, we have to gain some height here for the descent.

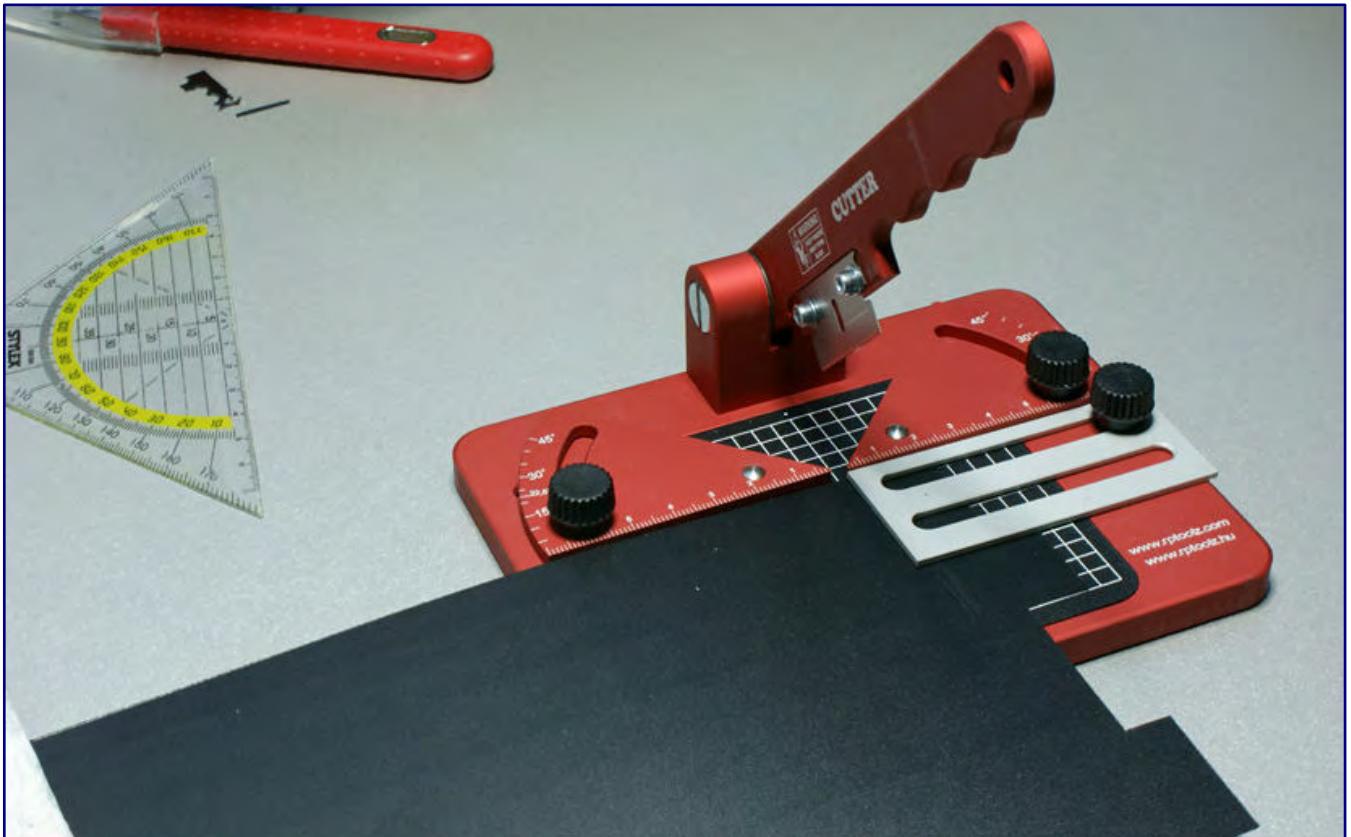

The mitre cutter tool (RP-CUTR) from RP Toolz helps us to produce several identically sized PS plate sections (Evergreen) to rest on the abutments of the bridge until a sufficient clearance height is achieved.

Now, it pays off that we have screwed the bridge on and can easily remove it again. Some material (polystyrene board from Evergreen; sold by Faller) is now added to the bridge piers and abutments until the missing millimetres are gained without making the track ascents too steep for short trains.

Compared to the manufacturer's instructions, we are now adding an important intermediate step at this point: We want to apply rust adhesions to the rail flanks in a prototypical manner. The easiest way to achieve this is with the detail markers from Noch (61155): The brown pigment pen is ideal for quickly and easily applying the desired traces of rust here.

There are certainly alternative methods and not everyone will like the strong brown colour, as the yellow components are often higher in the original. However, the colour impression also depends largely on the ambient light and the contrasting colours. We would therefore describe the solution chosen here as good and also suitable for beginners.

continues on page 24

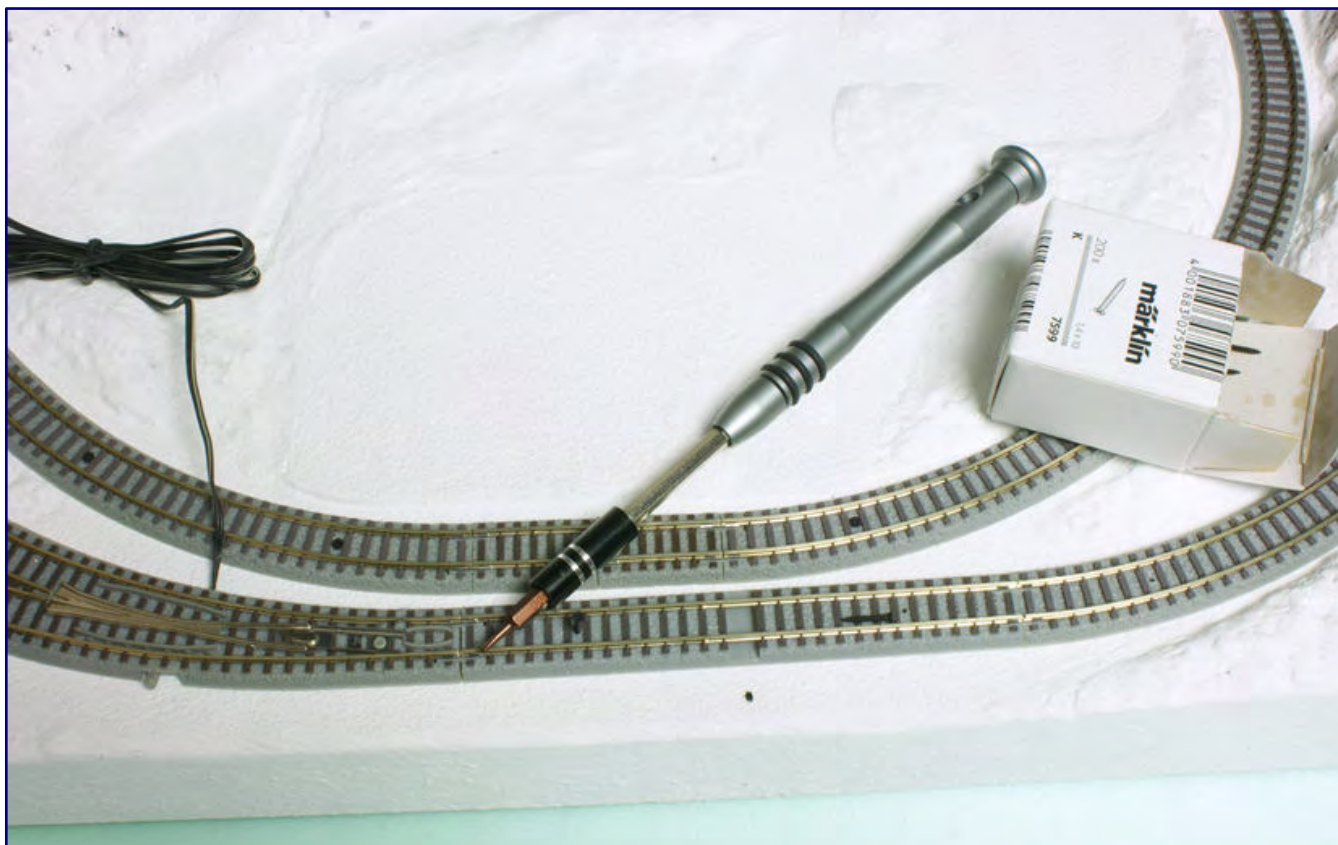

Contrary to the instructions, we opted for a screw fastening for the bridge (photo above), for which we created a screw hole on the pillar using a pin block and a 1.2 mm drill. Märklin has provided a screw hole on the right. The track screws 7599 (1.4 x 10 mm), which also fit the Rokuhan track, are to be used there (photo below). However, this should also be pre-drilled from below with 1.2 mm at the selected screw positions.



You need to be quick with these two work steps: as soon as access to the track in the tunnel is no longer required, the lower edge of the bedding is coated with Uhu Por adhesive (top image). The cover plate on which the track is to be bonded is then inserted with hot-melt adhesive (bottom image).

It is important that two adjacent track sections are first joined together and then painted over at the connecting lugs. So, we work our way up to the goal piece by piece with several short sections of track.

The rails are then firmly connected to the substrate, initially in the critical areas where there could be bumps and which are no longer accessible later on. The final gaps are closed accordingly, where we can maintain access for a long time and no critical displacements can occur in the track layout.

Noch recommends small track screws for fixing Rokuhan tracks. In many situations, contact bonding should also be completely sufficient, but in view of the stresses we expect due to temperature fluctuations during transport, we would like to follow their advice.



With the detail markers from Noch (61155), the rail flanks can easily be given a rust patina, in the tunnel, of course, before closing the floor. However, as the tip of the pen is too thick for this, a micro brush from the dental sector helps us with the application. It is easy to guide thanks to the "Holder 3D" from Zahn Pinsel presented in the trade fair issue.

We have already used the suggested Märklin track screws (7599), Philips screws 1.4 x 10 mm with size 00, on the bridge, and, so, we are again following the recommendation here. The number purchased is completely sufficient anyway, because Märklin meant well with 200 pieces in the small box.

The installation of the track in the tunnel section deserves a final mention at this point: After the laying work, the track is still floating freely in the tunnel and is not yet load-bearing. The layout is now turned upside down, the track is already fixed and will not fall loose.



The tracks that run through the tunnel are now exposed in front of us. Solvent-free adhesive (Uhu Por) is now dabbed onto the edges of the track bed. Hot glue is then applied from below to the finished terrain at the points, where the track base (PS construction board supplied in the correct shape) is to be attached.

The track base is then glued in place and further fixed to the sides from above with hot glue. After these three steps, the finished terrain can be turned back, and laid down. It is important to think through the assembly steps described carefully beforehand, and then carry them out quickly without pausing to think.



After the steps described in this first part, all test drives with the models intended for presentation, run without any problems. The next part starts with the design of the landscape.

The aim is to ensure that the adhesive does not dry through on the ballast bedding replica, while the floor slab is still being installed. It must be ensured that it also forms a force-fit connection with the base plate (tunnel base), and also securely fixes the rails in the tunnel section.

Finally, we can now define the power feed points on the straight rails with removable sleeper strip element. They should be selected and aligned as inconspicuously, as possible. We then also drill holes for the connection cables to pass downwards at the specified points.

This marks the first step in the construction of our layout. We can now experience the fun of operation, and look forward to designing and equipping it, further. We will then start this process in the following part of our annual focus series.

**Basic supplier of our project:**

<https://www.noch.de>  
<https://www.rokuhan.de>

**Other providers mentioned:**

<https://www.faller.de>  
<https://www.maerklin.de>  
<https://www.rptoolz.com>

<https://www.uhu.de>  
<https://viessmann-modell.com>  
<https://www.zahn-pinsel.com>

The magical dust fairy

## Dusting up!

***Dust is the enemy of model railways. Even Hamburg's Miniatur-Wunderland has integrated the time-consuming cleaning of its large exhibition layout into its regular work processes, as evidenced by the company's own reports. Dust accumulation can be avoided by covering the landscape, but in operation or even at exhibitions, our elaborately constructed model railways are defencelessly exposed to the falling suspended particles. So, dusting up is essential, but how?***

It must have been more than thirty years since a tool called the "Dust Witch" made its name in the hobby. As a device that would be attached to a regular vacuum cleaner, it promised easy and accident-free cleaning of a model railway layout.

Long before the start of this millennium, however, the product seemed to have disappeared from the market. The once so effectively (and long before the multimedia age) advertised device was still well-known, but no longer available, anywhere. But it never seemed to be forgotten.



The Staubfee (Dust Fairy) 3.0 from Franke WF consists of these components, which we explore in this article.

Then, at the 2017 Nuremberg Toy Fair, Lux-Modellbau announced a relaunch of the tool under the name Staubhexe 2.17. In retrospect, we see the extension of the product name as a reference to February of the year of the relaunch, as this is exactly when the presentation took place.

Our editorial team also perceived a noticeable interest, which undoubtedly generated a high demand. Unfortunately, seven years have passed since then and despite earlier statements that the product would soon be delivered, things seemed to go nowhere.

With the outbreak of the coronavirus pandemic, things finally went quiet around Lux-Modellbau and its announcement. From our many conversations at trade fairs, it seems that hardly any readers still believe that it will be released, nor do we, by the way.



With its conical connector, the Staubfee fits on almost every end piece of any floor-running vacuum cleaner of all makes.

Consequently, interest in alternatives is high. These are available on various platforms with different names, production methods and sometimes at prices that are hard to swallow. But, eventually, we came across a comparable device that incorporated new ideas for increased performance and customised control.

This alternative is called Staubfee (Dust Fairy). And, we would like to introduce and explain this tool today, with the aim of demonstrating its practical application in a follow-up article.

## Description of the device

The Staubfee from Franke WF is a low-cost blowing and suction attachment for commercially available vacuum cleaners, and, as such, similar to the now almost historical original "Staubhexe" device. It is manufactured through a 3D filament printing process, which allows customised production, in manageable quantities.

It can be almost completely disassembled, and its components are made of polylactides (PLA), also known colloquially as polylactic acids. This material is one of the most commonly used materials for FDM printing.



This image reveals the manufacturing technique chosen for the device, namely PLA 3D filament printing. This can be seen most easily in the centre section of the body, where the print layers are particularly visible on the inside of the connection. The view through the connection piece is in the direction of the front and smaller fan wheel, which is driven by the air flow of the vacuum cleaner.

PLA has low moisture absorption and flammability, but high UV resistance and colour fastness. Its weight-to-strength ratio is relatively high. On the other hand, it has low temperature resistance, as it is a thermoplastic material.

The manufacturer, therefore, warns against exposing the device to temperatures above 40° C, as, otherwise, deformation may occur. It should therefore be kept away from direct sunlight, especially during the summer months.

Saying that PLA is easy to process is almost self-evident, because otherwise it would hardly be an option for the 3D printing process.

However, we feel it is important to point out that the moving parts inside the appliance are mounted on ball bearings.

This makes for smooth running, increases efficiency, and reduces



Inside, two fan wheels are mounted on a common shaft – the photo shows the larger one, which is positioned at the rear. They generate counter-rotating currents. All moving parts are mounted on ball bearings.

wear. The device needs to be attached to the end of a vacuum cleaner hose and is, therefore, not a stand-alone tool, but an extension of an electrical appliance, that is available in every household.

Due to the manufacturing method, print layers are recognisable, and small filament threads can also adhere to parts before they are used for the first time. The fact that the surface is not as smooth as that of injection-moulded parts, is, therefore, not a quality defect, but a result inherent in the manufacturing process. It does not impair the function.



The suction flow passes the inner blower nozzle in the ring in the direction of the vacuum cleaner bag. Should a figure or model part be sucked up, the grid-shaped coarse filter should hold it back and make it easier to find again.

Although we are presenting this valuable tool today primarily as a helper for cleaning the delicate landscape of layouts, there are many other conceivable applications that may justify the purchase: A wide variety of models and model vehicles can of course also be cleaned of dust, and the same applies to clamp-on building blocks, lamps, books and even textiles. And there are surely even more uses.

## Operating principle and effectiveness

Two fan wheels, which are mounted on a common shaft, generate two counter-rotating air movements inside the tool. The smaller fan wheel at the front is set in rotation by the vacuum generated by the vacuum cleaner.

Meanwhile, the simultaneously rotating, larger fan wheel at the rear end transports ambient air from the rotary vane to the front where it is ejected as a jet via the small internal nozzle. This blast stream picks up dust accumulations on the layout, which then enters the effective range of the surrounding, outer nozzle.

This is where the suction flow from the vacuum cleaner comes into action, by absorbing the dust swirling in the air and transporting it towards the bag. This enables good cleaning performance without contacting the layout, the most important argument in favour of this tool (as well as for the Dust Witch tool that has been known for decades).



**A key feature is this rotary slider on the back of the device, which is used to set the blowing power: In the "Maximum" position shown here, the fan slots are fully open and the Staubfee draws in the highest possible volume of air. However, if they are closed, the device generates a suction flow only.**

Simultaneously blowing away and sucking up the dust prevents small and delicate objects from being sucked in and damaged. It is therefore not only used for cleaning model railway scenery, but also for other household tasks, where these properties are desirable.

Thanks to its conically shaped connection, the Staubfee is not limited to a single brand or even type of vacuum cleaner. It proves to be compatible with almost every end piece of a vacuum cleaner hose. We have included this small caveat for the sake of caution, as we are not familiar with all household appliances used worldwide, and, therefore, cannot guarantee that for every single type of vacuum cleaner.

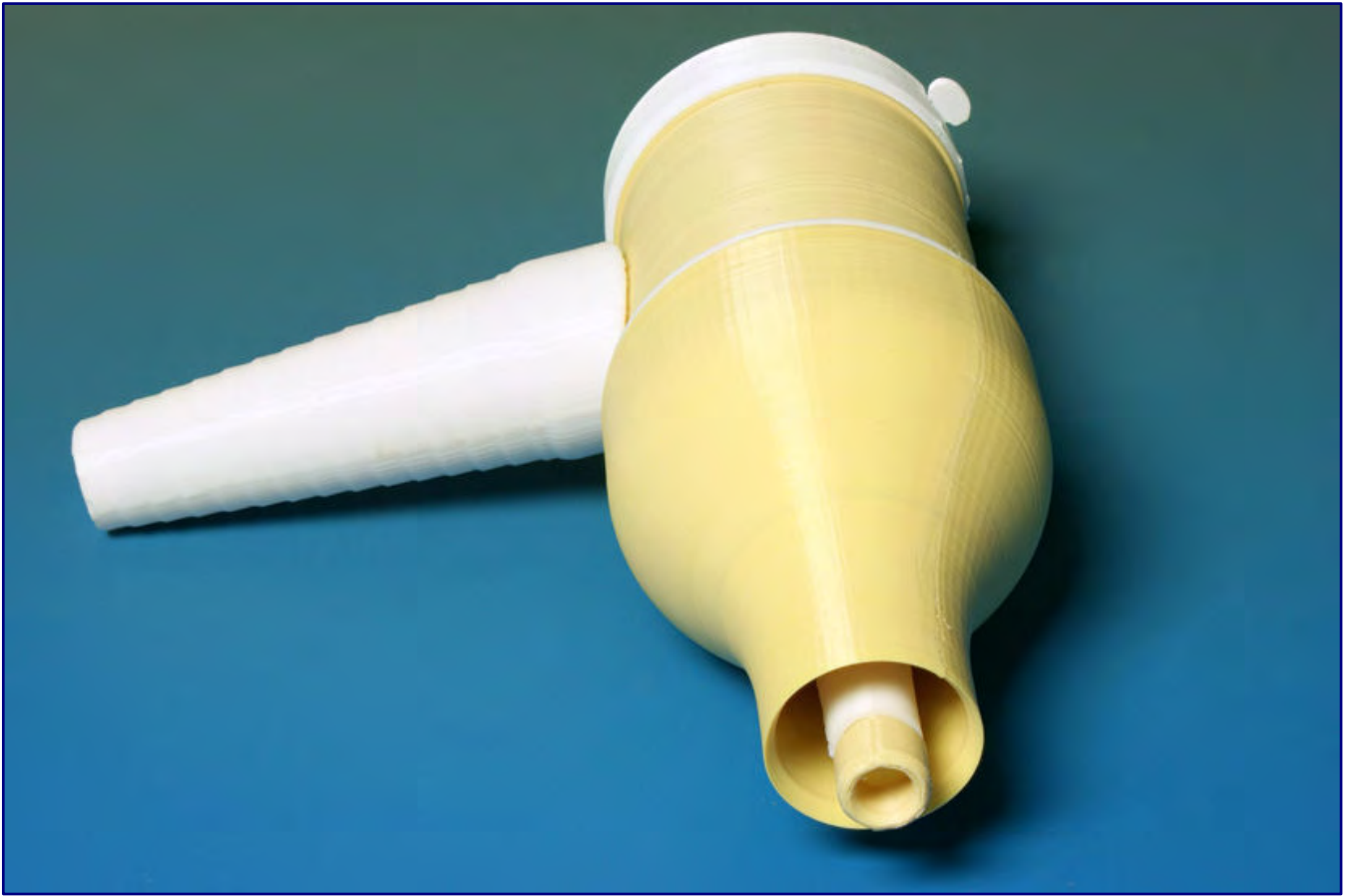

This is what the fully assembled third-generation Staubfee looks like: The outer nozzle (see photo on page 19) is now also fitted. The removable attachment for the inner nozzle, which can be seen here, provides a significant increase in performance compared to the previously available Dust Witch.

It should not go unmentioned that the Staubfee 3.0, as it is presented to us, is not a copy of the Staubhexe offered decades ago, whose relaunch many model railway enthusiasts have been waiting for in vain for seven years now.

Although the alternative in front of us works according to the same basic principle, it features many design solutions that have increased both performance and effectiveness. One example is the air ducts, which make it possible to direct the generated airflow more precisely and effectively onto the inner nozzle.

The Staubfee also has a rotary valve at the rear end that can be used to continuously adjust the blowing power. When fully closed, it only vacuums, while when fully open, the full blowing power is also emitted through the inner nozzle.

The blowing performance has been stabilised considerably by a rubber O-ring, which effectively seals both air flows against each other between the inner nozzle and the inner part of the suction pipe. The last optimisation, which is a feature of the version 3.0 we tested, concerns the large fan wheel of the pressure stage.

The number and orientation of the fan blades have been changed here, which has increased the blowing power even further. This is another major step forward, because without a powerful and focusable blowing jet, the attachment would just be an ordinary Hoover nozzle. The only difference to the attachments supplied with every vacuum cleaner would be the special shape and individual size.

## Application and cleaning

Operating the Staubfee is very simple: after connecting it to the suction hose, it is held and guided with the favoured hand on the vacuum cleaner connection. The vacuum cleaner is switched on as usual and its suction power can be set as required.

With the other hand, the individual ratio of blowing to suction power can be changed using the rotary slide. The individual airflow setting depends on the object to be cleaned: fine objects such as figures should not be blown over or even sucked in, but the deposited, suspended, particles should effectively disappear from grass fibres and other green material, so as not to form a grey haze on them.

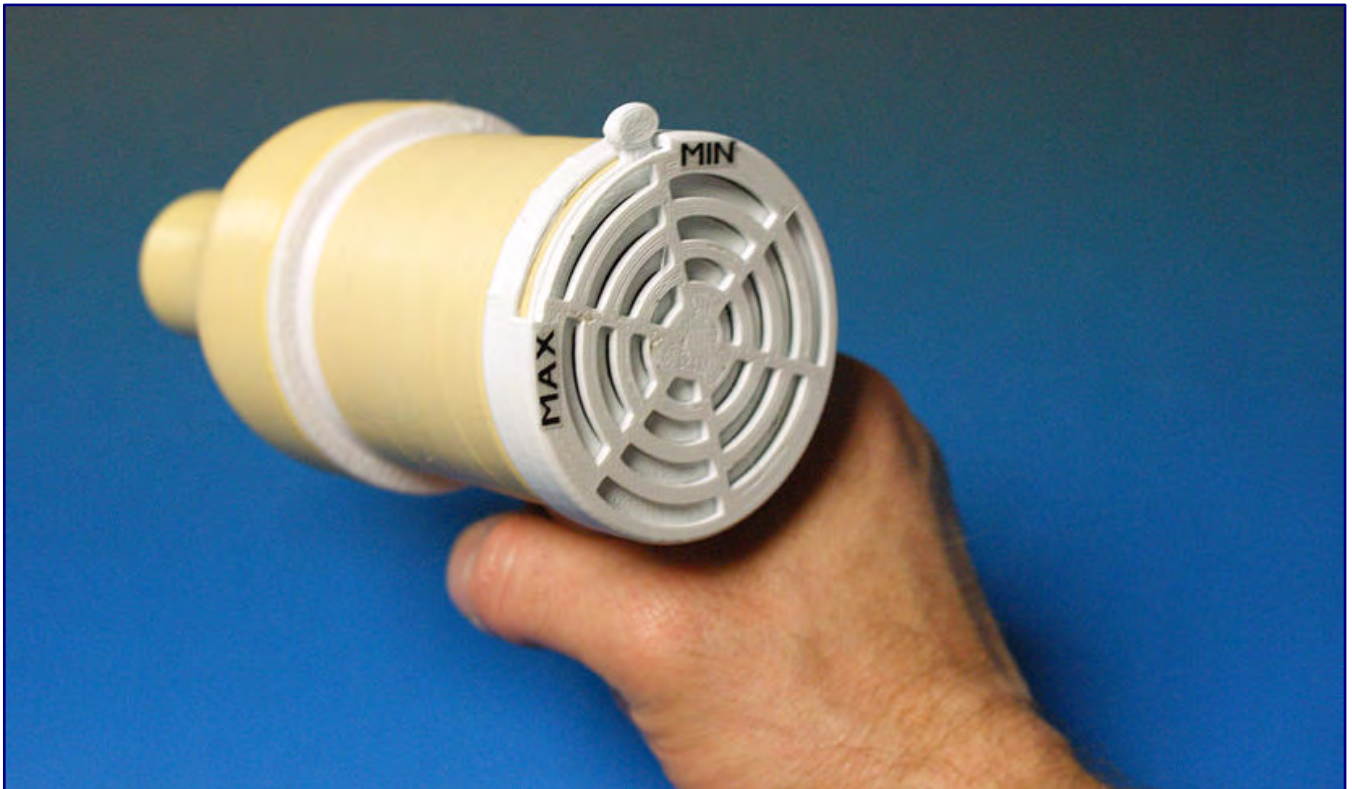

The dust fairy is held by its connection to the vacuum cleaner or its end piece during use. It then sits comfortably in the hand and can be easily guided over the sections of the layout that are to be cleaned. In this image it is set to pure suction power, as the rotary valve is closed.

As with any new device, it is advisable to familiarise yourself with this tool first so that you can correctly assess its performance and capabilities and put it to its best possible use. Then, everyone will quickly learn to appreciate it.

After use, it is safely stored in the dispatch box. If you want to save space and keep the container as small as possible, the Dust Fairy can be almost completely dismantled. The connecting piece (white) can be removed, as can the outer nozzle (beige). The supplied sealing cap (also white) fits onto the rotary valve at the rear end (white).

The most sensitive part is certainly the small extension (beige) for the white inner nozzle. Franke WF has deliberately refrained from permanently extending the inner nozzle, instead designing this part as a clip-on piece. This requires a little caution, but allows older versions to be retrofitted, and also allows a more diffuse, less focussed swirl jet, if the user so desires, on a case-by-case basis.



The part consisting of the inner nozzle and the air ducts can also be removed from the main body (beige) in the same way as the end cap with the rotary slide (both white). This is done relatively easy with the end cap, but the nozzle part sits very firmly on the main body with the Hoover nozzle.

We have, therefore, refrained from removing the nozzle for photos, and prefer to show its interior using the manufacturer's CAD illustrations. We did not want to risk damaging it, as disassembly, at this point, is not necessary, in principle.



**The efficiency of this tool can hardly be observed at the time of use. However, when the outer nozzle is removed after just five minutes of trial use, the particle and dust ring on the coarse filter reveals the cleaning performance all the more clearly!**

It is sufficient to remove the beige-coloured outer nozzle to reach it from the outside. Only the mesh screen at the base is relevant for our access, because the suction flow is guided through it (and further out past the air ducts) to the vacuum cleaner tube.

If a figurine or small part really does get sucked up, it will get stuck here and is easy to salvage. As soon as the job is finished, we take a look here and clean the grid sieve directly with the vacuum generated by the Hoover. This keeps the dust fairly clean and ready for future use.

If desired, the part with the inner nozzle and the end cap with the rotary valve to the main body can also be firmly and permanently connected. We do not consider this necessary, but it is up to the end user to decide. In this case, commercially available superglue would be the method of choice.

To conclude our product presentation, we have some good information for all those who are already familiar with previous versions of the device. Those who appreciate it may now want to upgrade versions 1 and 2 to the higher performance level.

Franke WF also offers owners the necessary retrofit parts to modify an existing appliance to the Staubfee 3.0 presented here. They can all be purchased, retroactively, as soon as the version of the basic appliance has been identified.



After a convincing test, the Staubfee 3.0 is set to be a sure bet for many practical uses that require the gentle removal of dust from layouts and dioramas without having to worry about the permanent loss of loose parts.

They are supplied together with illustrated instructions that explain the necessary disassembly and the insertion or replacement of parts. Defective parts can also be ordered as replacements. After all, model railway enthusiasts should be able to enjoy and successfully use this tool for years to come.

From now on, this group of people also includes us. And, because it has convinced us, we are nominating this new version 3.0 Staubfee for the 2024 best new release in the technology category.

Supplier contact:  
[Franke.wf\(at\)web.de](mailto:Franke.wf(at)web.de)

**Grenzenloser Modellbahnspaß in 1:220**

**9. Internationales  
Spur-Z-Weekend**



# **ALTENBEKEN**

**04. und 05. Mai 2024**

**Samstag: 10.00 - 18.00 Uhr**

**Sonntag: 11.00 - 17.00 Uhr**

**Eggelandhalle, Gardeweg 8**

**33184 Altenbeken**



**Z-Freunde International e.V., Brandenburg 6, 56856 Zell/Mosel**

**[www.z-freunde-international.de](http://www.z-freunde-international.de)**

Note for English readers: The literature section that follows is not translated into English because the original texts of the books involved are in the German language. The original German is left here for information purposes only.

## Geschichten hinter dem Miniatur-Wunderland **Wenn Kinderträume wahr werden**

*Die Modellbahn bietet selten Anlass für einen Kinobesuch. Doch wenn es um die Lebensgeschichte der Zwillingbrüder Frederik und Gerrit Braun mit ihrem Erfolgswerk Miniatur-Wunderland geht, dann sieht das schon völlig anders aus. Zwar spielt die Eisenbahn bei ihnen eher eine Nebenrolle, aber Emotionen und Leidenschaft kommen auch in Hamburg nicht zu kurz.*

Sabine Howe (Regisseurin)  
Wunderland  
Vom Kindheitstraum zum Welterfolg

B|14 Film GmbH Produktion in Koproduktion mit Tobis  
Berlin 2023

Bildformat 16:9  
Tonformat 5.1 Digital  
Sprache deutsch  
Laufzeit 89 Min.

Seit 7. März 2024  
in Ihrem Kino



2000 erwuchs aus einer spontanen Idee, geboren in Zürich, ein Projekt, das zur größten Modelleisenbahn der Welt werden sollte. 1,5 Millionen Menschen aus aller Welt besuchen heute jährlich das Miniatur-Wunderland in Hamburg und haben es zu Deutschlands beliebtester Touristenattraktion werden lassen.

Ganz offensichtlich sehnen sich nicht nur die Zwillinge Frederik und Gerrit Braun nach einer weitgehend heilen und funktionierenden Welt. Für viele Menschen ist ihre Schauanlage zu einem Sehnsuchtsort geworden, der verzaubert und es für einige Stunden ermöglicht, abzutauchen und eine andere Welt in ihren vielen Details zu entdecken.

Lebendig wird diese Welt neben den Personen, die sie ersinnen und gestalten, durch die vielen Figuren, die dort zu finden sind. Sie haben Kinder, tragen Mützen und Schuhe, sind verliebt oder singen vor sich hin. Sie lächeln und weinen; gleich, welchen Beruf sie auszuüben zu scheinen: Sie erzählen Geschichten, wie sie auch das echte Leben erzählt.

Diese Emotionen, die dort einfließen und die das Gezeigte ausstrahlt, machen den Unterschied zu anderen Anlagen, die öffentlich präsentiert werden. Das Miniatur-Wunderland ist nicht betriebswirtschaftlich durchgerechnet und auf Gewinnmaximierung ausgerichtet: Sein Erfolg erklärt sich durch den Fokus auf Leidenschaft und Gefühle.

Wer es nicht kennt, wird den Film leider nicht verstehen. Wer davon gehört hat und es besuchen möchte, wird schnell dem Zauber erliegen und die Reise endlich auf sich nehmen. Und wer es kennt wie auch schätzt, der wird nach diesem großartigen Werk schließlich verstehen, woraus die eigene Begeisterung erwächst.

Die Dokumentation erzählt die Geschichte hinter diesem Welterfolg. Es geht um Kindheitsträume und eine Kindheit, die alles andere als die heile Welt war und um zwei Lebenskünstler, die sich immer wieder neu erfinden. Zu Wort kommen ihre Weggefährten, Mitarbeiter und anderen, die für entscheidende Wegpunkte und Richtungsänderungen gesorgt haben.

Unter der Regie von Sabine Howe erzählen die beiden Brüder von ihren Erinnerungen und Erlebnissen. Private Filmaufnahmen bebildern die Kindheit und zeigen ihre frühe Faszination, Alltagssituationen als Modell nachzubilden.

Den Anlass für dieses Werk lieferte die vor sieben Jahren erschienene und von uns ebenfalls rezensierte Autobiographie der Zwillingbrüder, doch hier wurde keinesfalls das Buch verfilmt. Die Schwerpunkte und zum großen Teil auch Inhalte sind jetzt völlig anders und neu gesetzt worden.

Ihre Zeit als Diskothekenbetreiber wird beispielsweise nur kurz gestreift und ebenfalls mit privatem Filmmaterial ausgeschmückt. In deren Räumen fanden erste Vorstellungstermine mit Modellbauern statt, die dort Probearbeiten fertigten. Und auch der Weg ihres Halbbruders Sebastian Drechsler in die eigene Mannschaft erfolgte eher auf Umwegen.

Mehr als 300 Mitarbeitende zählt das Unternehmen heute und sie alle geben dem Gezeigten seinen ganz besonderen Charakter, der aus der Kreativität und Phantasie all dieser Menschen entsteht. Chefmodellbauer Gerhard Dauscher erläutert diesen Prozess sehr anschaulich.

Schicksalhaft war auch ein Treffen mit der Familie Martinez aus Argentinien. Der Hauptteil des Films dreht sich um dieses Treffen, eine Idee, der Skepsis von Gerhard Dauscher und dem Weg, wie dann doch gemeinsam der Bau des jüngsten Abschnitts Südamerika angegangen worden ist. Vieles an dieser Stelle ist für den Rezensenten sehr eindrücklich, konnte er doch auch schon mehrfach persönlich mit den Modellbaubegeisterten aus Buenos Aires sprechen.

Um zwischen Modellen und Menschen einen roten Faden herstellen und eine Chronologie schaffen zu können, mussten die kindlichen Zwillinge in ihre eigene Anlage eintauchen. Sie wurden dazu digital reproduziert, auf Aussehen und Größe der Wunderland-Bewohner gebracht und animiert zum Leben erweckt. So nehmen sie den Kinobesucher mit auf eine Reise durch ihre Welt.

Verblüffend genug scheint, dass eine solche Dokumentation den Sprung auf die Kinoleinwand schafft, werden solche Produktionen doch sonst eher für Plattformen wie Netflix umgesetzt. Aber auch dieses Phänomen zeigt, wie groß die Gemeinde der Miwula-Anhänger ist und welche Emotionen hier geweckt werden.

Spannend bleibt die Frage, wie viele Wochen sich der Film in den großen und kleinen Kinosälen des Lands halten können. Wir wünschen ihm viel Erfolg und freuen uns, wenn die Modelleisenbahn, die in Hamburg wie auch in diesem Film eher eine (wenn auch nicht unwichtige) Nebenrolle spielt, so für einen möglichst langen Zeitraum im Fokus der Öffentlichkeit bleibt und sie weiter salonfähig macht.

Doch auch im Falle, dass mit Erscheinen dieser Rezension kein Kinobesuch mehr möglich sein sollte, wird sie ihren Zweck erfüllen: Ein weiteres Verwerten des Materials auf den genannten Plattformen sollte sich für die Verleihgesellschaft gewiss lohnen, denn ein Erfolg war dieser Film schon jetzt, wenn die Erwartungen realistisch eingeschätzt wurden.

Uns wird der Streifen gewiss lange nicht aus dem Kopf gehen und bei jedem Besuch in Hamburg auf ein Neues lebendig werden. Und so wünschen wir uns auch, dass er vielleicht auch auf digitalen Datenträgern käuflich zu erwerben sein wird!

Information on film and cinemas:  
<https://tobis.de>  
<https://www.miniatur-wunderland.de/kinofilm/kinos/>

Offene Wagen nach 1945

## Vom Zwei- zum Vierachser

**180 Seiten Informationen zu offenen Wagen ab 1945, nicht nur eingeschränkt auf DB und DR, sind eine Menge Stoff. Zusammen mit der ersten Broschüre ergeben sie ein Buch von nicht gerade geringem Umfang. Was als Ergänzung eines Buchtitels gedacht war, erfuhr das Ausmaß eines Fortsetzungsbands. Wir haben uns das neueste Meisterwerk von Stefan Carstens angesehen.**

Stefan Carstens  
Offene Wagen (2)  
Hintergrundinformationen, Modell-Bauanleitungen und Basteltipps

Modellbahn Union  
Kamen 2023

Broschüre mit Klebebindung  
Format 21,0 x 29,7 cm  
180 Seiten mit ca. 500 teilweise farbigen Fotos,  
ca. 30 Originalzeichnungen und Faksimile

EAN 4063956096868  
Art.-Nr. MU-H0-Q00009  
Preis 32,90 EUR (Deutschland)

Erhältlich direkt ab Verlag  
und bei ausgewählten Vertriebspartnern



Auch die heute zu besprechende Broschüre baut auf Band 3 der Güterwagen-Reihe auf, die 1996 erstmals erschien. Nach fast 30 Jahren ist dieses Buch, mit dem Stefan Carstens seine Karriere als Deutschlands bester Güterwagenkenner fortzusetzen wusste, in vielen Punkten nicht mehr aktuell.

Das Ergänzen des darin niedergeschriebenen Wissens schien folglich überfällig. Das gilt sowohl für die Modellseite mit in der Zwischenzeit neu erschienenen Güterwagenmodellen als auch für die Vorbildinformationen, die seitdem zugänglich geworden sind und sich auswerten ließen.

So manche frühere Information konnte daher ergänzt werden oder stellte sich gar als falsch heraus und wird im vorliegenden Heft richtiggestellt. Wie wir es von den Autoren rund um Stefan Carstens gewohnt sind, werden auch in diesem Sonderheft wieder sowohl die Vorbilder als auch, stets im Folgekapitel platziert, die zugehörigen Modelle behandelt.

Leider, so möchten wir sagen, beschränken sich die Modellabhandlungen alle auf die Baugröße H0. Sämtliche anderen Spurweiten fanden hier keinen Eingang, was auch im Buch so der Fall war, das hier sinnvoll ergänzt wird.

Und doch gibt es auch in diesem Teil Neuerungen: Folgt den Modellbesprechungen und Verfeinerungsvorschlägen stets dem höchstmöglichen Anspruch, so zeigen sich alle Autoren inzwischen erheblich kompromissbereiter.

Genau das eröffnet dann auch einen neuen Leserkreis, denn die Mehrheit der Modellbahner wird mit ihren Käufen zufrieden sein und ist bereit zu Kompromissen. Nicht gern erfahren Personen aus dieser Käuferschicht viele Dinge, die nicht perfekt sind und sich vielleicht besser lösen ließen, denn vor allem auch der Preis ist als Entscheidungsfaktor nicht zu vergessen.

Und so galt es hier wohl, die oft gegensätzlichen Interessen des Hobbymodellbauers und der Perfektionisten in einer Weise zu vereinen, die niemanden zurücklässt. Diese Aufgabe halten wir für gut gelöst.

Die vorgestellten Modelle, die 1996 noch nicht am Markt verfügbar waren, werden wertschätzend und durchaus lobend vorgestellt. Verfeinerungsmöglichkeiten werden einzeln so aufgezeigt, dass es jedem leicht fallen wird, den individuellen Grad an Nacharbeiten am eigenen Können auszurichten und zu bestimmen.

Es sind sogar Modelle aufgeführt, bei denen sich mögliche Optimierungen wirklich auf ein Minimum beschränken, des Weiteren haben auch das Anbringen von Betriebsspuren und Schmutz eigene Modellartikel im Heft erfahren.

Dieser Teil des Hefts, der – ohne exakt nachgezählt zu haben – rund ein Drittel des Umfangs ausmachen dürfte, wird zweifelsfrei den Vertrieb des wichtigsten Handelspartners unterstützen, denn ein enger Bezug zu dessen Warenangebot ergibt sich hier schon zwangsläufig und in eben auch gelungener Weise. Doch wir müssen natürlich auch die Vorbildseite noch betrachten.

Wie es schon anklang, dreht sich in der zweiten Broschüre alles um die Entwicklung nach 1945: Die Spanne reicht von den ersten wiederaufgebauten Wagen bei DB und DR über die Entwicklung moderner Zweiachser mit stählernen Wagenkästen, die aus Umbau, Modernisierung oder komplettem Neubau hervorgingen, bis zu den vierachsigen Bauarten, die heute allein das Bild der Eisenbahn bestimmen.

Gut nachgezeichnet ist das Beharren der DB auf zweiachsigen Wagen, während ringsherum der Trend längst zu längeren Wagen auf Drehgestellen ging, und die Sonderrolle der DR, die aus Materialknappheit heraus den Sprung zum Vierachser vollziehen musste.

Dieses Phänomen ist durch statistische Daten, die Materialeinsatz und Nutzen in Relation setzen, sehr anschaulich vermittelt worden. Verwunderlich schien, dass die kürzeren Wagen in den achtziger Jahren noch mal eine Renaissance erlebten, die ebenfalls auf die besonderen Probleme von Planwirtschaft und realem Sozialismus zurückzuführen war.

Mit perfekt ausgewählten Fotografien und unterstützt durch ansprechende und anschauliche Zeichnungen werden alle Beschreibungen dokumentiert wie unterlegt, die tadellose Reproduktion der historischen Fotos tut dabei ihr übriges.

Stets richtet sich der Blick dabei auch über die Grenzen Deutschland hinweg, denn der von DB und SNCF gegründete Europ-Pool und die Standardisierungen der UIC stellen wichtige Faktoren für die Beschaffung von Wagen dar, die eben nicht nur bis zur Landesgrenze liefern.

Waren es anfangs noch im Ausland verbliebene Reichsbahn-Wagen, die bei den einstigen Kriegsgegnern eine neue Nutzung erfuhren und landestypisch angepasst wurden, nahm ein spannendes Thema schnell an Fahrt auf.

Bei allen Gemeinsamkeiten der UIC-Standardwagen beleuchten die Autoren auch die verwaltungstypischen Merkmale, die sie unterschieden oder die nach Verkäufen herbeigeführt wurden. Dies erwähnen wir deshalb so sehr, weil sich hier wieder eine Brücke zu den Modellen auftut.

Auch, wenn in der Broschüre nur die Nenngröße H0 behandelt wird, so liefern die Berichte und Aufnahmen viele Ideen und Anregungen für Projekte im eigenen Maßstab der Wahl. Und so wird diese Lektüre noch lange Zeit nachwirken.

• Publishing pages and purchase:  
• <https://www.stefancarstens.de>  
• <https://www.modellbahnunion.com>

Report from the Faszination Modellbahn

## On a Day Trip to Mannheim

***Faszination Modellbahn in Mannheim from 8 to 10 March 2024 was the first public exhibition after the presentation of new products in Nürnberg (Nuremberg). And although there was an opening day for end customers there for the second time on Saturday, on which Hall 7A (model railway and construction) was open to everyone, some major manufacturers preferred to use the event in Mannheim. Almost 15,000 visitors responded to their call.***

By Ralf Junius. After another token strike at Deutsche Bahn ended on Friday afternoon, nothing was standing in the way of my day trip to Mannheim. So, on Saturday, 9 March, I set off south from Düsseldorf at around 6.30 am.

After just over two hours, I reached my destination and was able to join the waiting line at the entrance to the Maimarkt site shortly before 9:00 am. Spread over three days of the event, almost 15,000 other people did the same. After only a short wait, I finally entered the exhibition hall.



The first place to go at the fair was the Märklin booth. Among other things, the V 125 diesel locomotive of the Württembergische Eisenbahn-Gesellschaft (item no. 88211) with the two mushroom shaped vents on the long engine hood could be seen there.

I immediately noticed the very wide aisles. My last visit to this trade fair was before the coronavirus pandemic and I remembered a different view from that time. Saturday remained pleasant throughout the day, despite the large number of visitors. Only in front of the layout and sales booths did it get a little crowded, otherwise, there was always enough space to walk from booth to booth.





An unpainted hand sample of the V 90, we were already able to show a painted and labelled one in our report from Nuremberg, allowed us to study many of the details reproduced by Märklin.

Manufacturers, dealers, and layouts of all gauges were spread throughout the hall. As a Zettie, I was first drawn to the Märklin booth to see the new 2024 models in person. In addition to the insider model “Schweineschnäuzchen” (piggy’s snout) VT 88<sup>9</sup>, samples of the V 125, V 90 and the class 103 for the EC 63 “Mozart” were also presented there. In addition to the new products, the company’s own exhibition layout was of course also on display.

Several booths offered hands-on activities to get the next generation interested in our wonderful hobby. From the play mat and the autonomous control of a train to the tinkering workshop and the opportunity to build a house or a mini diorama in the BDEF’s “Junior College Europe,” these offers were very popular.

Many different scales were represented among the exhibited layouts. The Miba personal layout competition also took place again as part of the exhibition. This was won by Jonas Sommer with his layout “Kent’s Mainline in Miniature.” By the way, not a single Z-scale layout competed here.

The Z-Freunde International booth was a centre of attraction for all fans of our scale. Various exhibits were presented there: The Z-Stammtisch Rhein-Neckar had set up a track for long trains with the motto “Kringel um die Großen” (“Curls around the big ones”), and had train compositions based on original trains running on the track and circling around an H0-gauge train.

Adjacent to this, the Radolfzell Z gauge regulars’ table exhibited its regulars’ table boards. A picture frame with a commuting rail bus was also on display. Thomas Heß showed on Klappingen that digital technologies are also possible for Zetties.

continues on page 43



Not on the winners' podium, but still very worth seeing: "Holzwarenfabrikation Bernhard Brettl" (wooden products fabrication) by Iлона Rüger (top photo) and (below) "The Gnat Shack IV – Schotterwerke" (gravel factories) by Heiko Wendler (bottom photo).

And things are also continuing digitally: Claudius Veit (Velmo) presented his chemical plant in very diversified operation, which also includes moving road traffic. New from the Velmo workshop is a digital decoder for the latest version of the E 41, which is now about to go into production.



In the picture frame of the Radolfzell Z gauge club, a rail bus commuted back and forth before viewers.

This is already the third version for the model series, as Märklin has so far made modifications to this locomotive with each new model, which then also resulted in an adaptation of the decoder. The new model presented in Mannheim also corrects the swapped tail and lower headlights (see brief review in the **Trainini**® 2/2024 news).

A lot of space was given to Z-Lights, where Torsten Schubert presented his LED models and soldering demonstrations. Thanks to Oliver Kessler's Z-Car system, moving vehicles on a scale of 1:220 have been a reality for seven years now. At Faszination Modellbahn, he presented a new chassis, for which he used a 1:160 scale VW bus as a demonstration model to show visitors how to use it on the next larger scale.

The Z-Freunde International contributed a display case with several models and their annual and special wagons in their booth. Roland Kimmich and Christine Specht were also represented at their booth with dioramas on which they exhibited Railex classics.

Several miniature layouts were set up by the Stammtisch Bayern. On two of them, visitors were able to start the train at the push of a button, in other words, set the signal to Hp 1. Ulrich Günther entertained the audience with his shunting layout, on which everyone was allowed to assemble a train themselves.

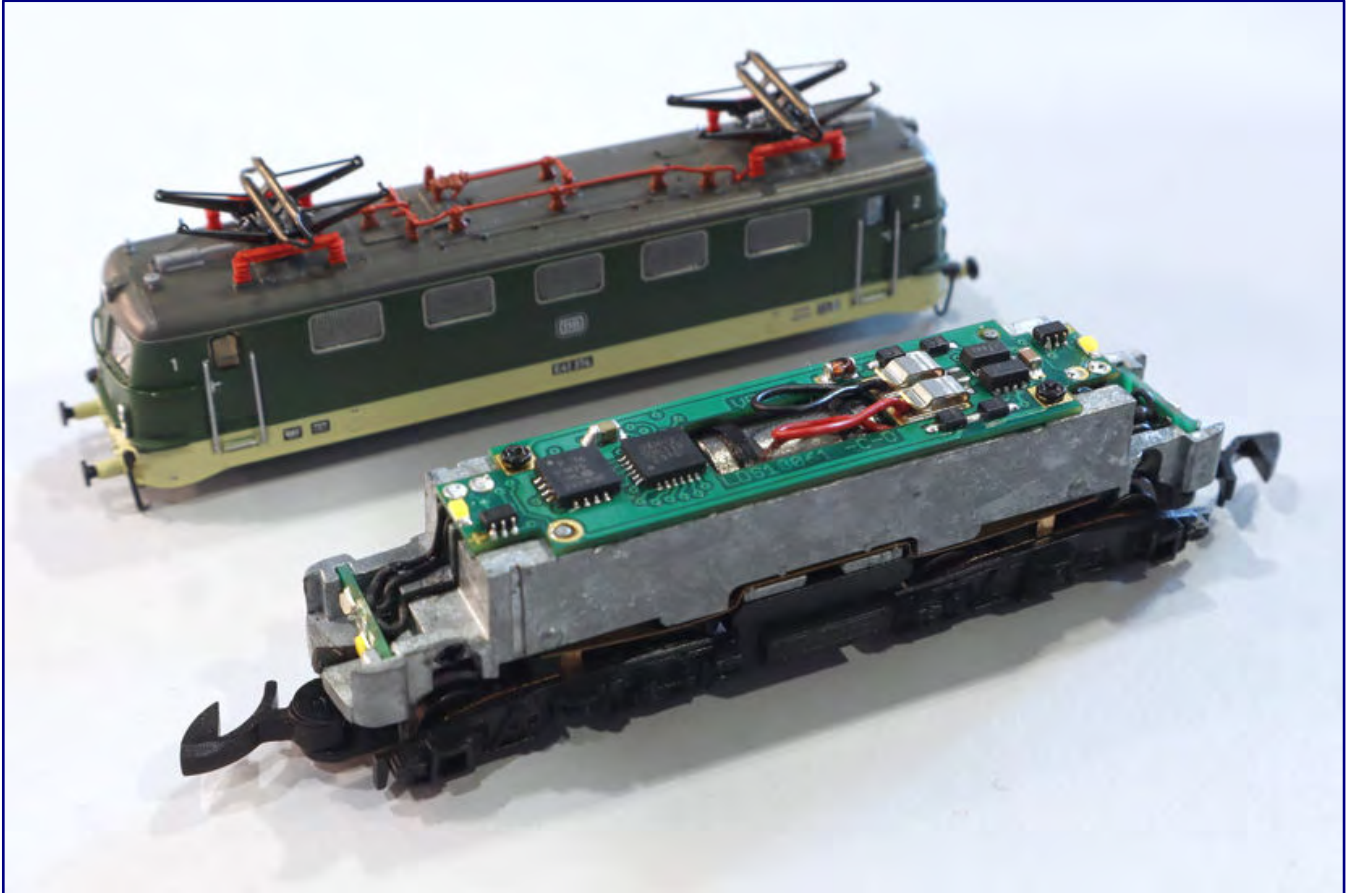

Claudius Veit presented a sample of a new Velmo decoder for the E 41 in Mannheim. After Märklin made changes to the chassis and circuit board mounting for this latest edition of the locomotive, a further decoder variant was required, which will now soon go into production.

Gotthard Schmidt and Manfred Forst concluded the Z gauge area with their layouts. A nostalgic layout depicting the eighties was on show by Gotthard Schmidt. Manfred Forst presented his Hunt's large coaling plant in his "coal box" and "Animalistics in Forstberg".



**Photo right:**  
The chemical plant had been heavily upgraded. New Ks signals were also installed, which today combine the functions of the distant and main signals. Two specimens can be seen here.

The day passed far too quickly to see and experience everything on site. After many intensive and as well interesting conversations, I returned home in late afternoon.



There is a lack of space near the factory entrance to the chemical plant, so a small signal bridge was installed here to mount the Ks signal with speed indicator.

Although not all the major manufacturers were represented, and especially not any small series manufacturers for Z gauge, it was still a nice and worthwhile visit for me. The electronics and digital suppliers not explicitly mentioned here and the specialised publishers, who should not be forgotten, certainly contributed to this.

**Exhibitor selection with Z gauge relevance:**

- <https://amw.huebsch.at/>
- <https://artitec.nl>
- <https://bdef.de>
  
- <https://www.busch-model.com>
- <https://shopware.donau-elektronik.de>
- <https://www.eisenbahn-kurier.de>
  
- <https://www.esu.eu>
- <https://www.hack-bruecken.de>
- <https://www.herpa.de>
  
- <https://www.mazero.de>
- <http://www.peter-post-wekzeuge.de>
- <https://tams-online.de>
  
- <https://www.uhlenbrock.de>
- <https://velmo.de>
- <https://viessmann-modell.com>
  
- <https://www.vgbahn.shop>
- <https://www.z-freunde-international.de>
- <https://www.zimo.at>
  
- <http://www.z-lights.de>
- <https://z-stammtisch-bayern.de>

# Ausstellung Modelleisenbahner Soest

*Modellbahnbörse*



*Fahrbetrieb auf  
allen Anlagen*

*Kaffee  
und  
Kuchen*

*Bratwurst  
vom Grill*

**Am 01. Mai 2024  
Von 11:00 bis 17:00 Uhr**

**Vereinsheim Neuengeseke  
Neuengeseker Heide 1**

**Eintrittspreis: Erwachsene 3,50 €**

**Jugendliche bis 16 Jahre 2,- € Kinder  
unter 6 Jahre frei**

**H0**

**TT**

**N**

**Z**

Readers' letters and messages

## Zetties and Trainini in Dialogue

**Thank you for each letter to the editor and all the feedback that reaches us. Write us (contact details are in imprint) - Trainini® lives from dialogue with you! Of course, this also applies to all suppliers in Z gauge, who would like to introduce innovations here. A representative sample is our goal. Likewise, here we note any events or meetings with significance to Z gauge reference, if we are informed in time.**

Questions about signals in the model:

Is there a description of where to place which signal?  
The signals in question are 8939, 89390, 89391, 89392, 89393, and 89394.

For example, the light signals 8939 and 89391 are identical. The 8939 is described as a main signal and the 89391 as a block signal. I don't want to describe all the possibilities in detail, but the most important ones should be correct.

Thomas Lindemann, Berlin

Editor's reply: Item numbers 8939 and 89391 are models of different generations for the same purpose and replicate block signals. They belong to the main signals. If we exclude the articles 89390 (leading light signal) and 89394 (light blocking signal), then your list contains further main light signals in the forms of entry (89392) and exit signals (89393). These are used to protect railway stations.

Helpful information on the possible signal patterns, their meaning, as well as the appropriate installation location, can be found in antiquarian booklets as Miba Report 17 by Stefan Carstens with the title "Signals Part 1: Main and distant signals" or, explained there rather on the basis of models, in the signal book of the manufacturer Viessmann (item no. 5299).

Confusion about manufacturers and nominations:

While reading the article about the awards for the new releases of 2023, I once again realised how small the market for our beautiful hobby is.

Michael Meißner, by E-Mail

Editor's reply: Azar Models is still very active, so it does not fit into the description of the article, which is why it cannot be included. At this point, however, we only evaluate new moulds or major revisions that almost correspond to such a model. The first model to be launched on the market is, therefore, always voted on.

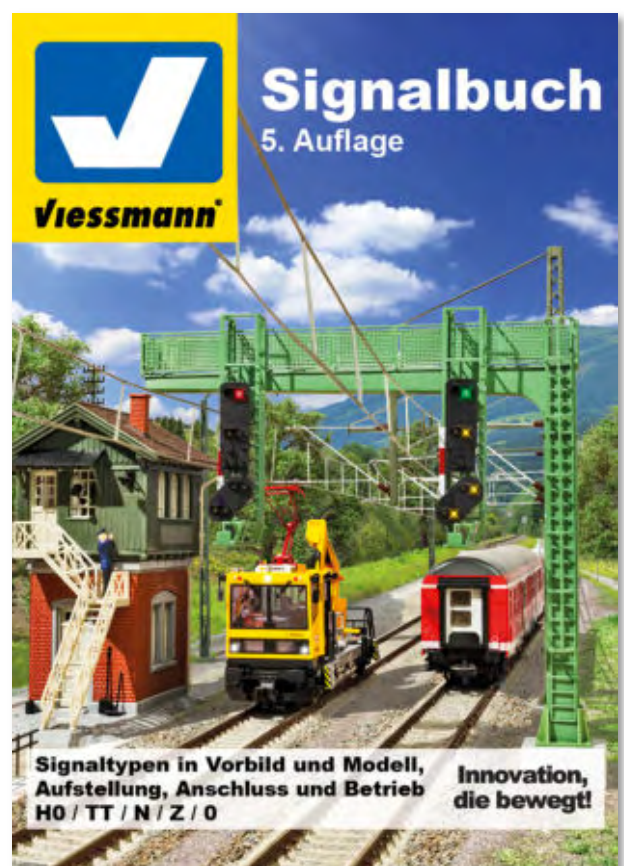

Viessmann-Signalbuch (Art.-Nr. 5299). Photo: Viessmann

However, one thing surprised me in the list of the few remaining manufacturers, whether small or large series, Azar was not mentioned at all, and it is precisely these manufacturers who are really endeavouring to gain a foothold with very respectable models.



**As part of the new releases of the year, we always evaluate the first variant of a new mould or fundamental revision to be delivered. This resulted in a few small selections for the 2023 review year.**

However, no such model was available from Azar Models during the period under review. This will certainly change when the announced TGV is released, which we are eagerly awaiting. As Azar Models is currently switching completely from 3D printing to plastic injection moulding, it is no longer so easy to classify this supplier correctly: Its possibilities are now definitely moving it in the direction of large-scale production.

#### **Views on the overhead line:**

(...) I celebrate the functional overhead line (with radially aligned masts in multi-track curves and corresponding cut-to-length contact wires: Provide pusher locomotive? Provide lead locomotive? Pull into the waiting area and lower the catenary, scheduled service pulls in, lower the catenary there, and so on.

A model railway is a model railway. The miniaturisation of reality fails due to the reduced dimensions, which can no longer guarantee stability per se. (...)

Uwe Pfannenschmidt, by E-Mail

#### **Controversial aspects of overhead lines and pantographs:**

Rarely has a report in Trainini upset me as much as the article "Who invented it?" about the Z overhead line. (...) Is there any evidence for the assertion that the Z overhead line is used by very few people?

(...) Then the illustration on page 7 above, Rokuhan can again be seen as the supposed standard. Is it a coincidence that the catenary, which is praised as being so much finer, is also further away from the camera lens than the supposedly so coarse counterpart from Märklin? Even from the less favourable angle for the Märklin model, is the difference really so brutal? I don't think so. And in the photo below, a completely unrealistic shorty is used as a counter-argument in favour of Märklin's overhead line philosophy.

(...) Your article is a good example of how, with the support of the trade press, endless demands are made, which then lead to model railways becoming increasingly unaffordable. (...)

I admit that I like the Sommerfeldt catenary better. If it doesn't pick up the current as well, I would stick with the Märklin model. And yes, the original overhead line made of punched sheet metal is out of date





In this photo, the viewing angle was more in favour of the Märklin pantograph. Nevertheless, its appearance is clearly inferior to its Rokuhan counterpart, especially as it does not even begin to lie flat on the roof of the dining car.

and could be updated with a somewhat finer, but still functional model. However, if I had to do without the functionality, I would stick with the previous version. (...)

Dietrich Frank, Düsseldorf

Editor's response: In consultation with our reader, we have had to make a major cut and answer further points in direct dialogue. The assertion that only a very small number of customers use the electric overhead line function has been verified: The ratio of electrified model route lengths can be determined from queried dealer sales and put in relation to the number of electric locomotive models sold. Incidentally, this also reflects our impressions from reader dialogues and trade fair observations.

We would like to respond to the reference to the photos on page 7 with a reference to page 6: Rokuhan and Märklin models can be seen there in opposite perspective. This also emphasises our statements. The Märklin pantographs are not to scale, and, when removed from the contact wire, do not lie anywhere near flat. They look more like a foreign body on the roof of a model.

We were pleased that the positive impression of the Sommerfeldt alternatives was confirmed. We have encouraged this supplier to think about further alternatives and retrofit offers in order to keep our scale attractive. There seems to be no doubt that the coarse Märklin punched parts for the contact wire are out of date.

We welcome every reader's opinion at this point, which enables us to engage in an extensive dialogue in order to contribute to and influence the future of Z-gauge in a targeted manner.

#### **A list of ideas for Noch:**

Our appeal in the Nuremberg video on our **Trainini TV** channel is working: We receive messages from some readers with great ideas for future car models, which we can still suggest for multicolour 3D printing at an agreed date at Intermodellbau.

Keep up the good work and let us know your ideas. We will collect them, prioritise them according to the number of mentions, and then add further information, such as the same or similar offers from the past.

We are keeping the result confidential so as not to make the subsequent process, which will take place at the accessories manufacturer, transparent and to be able to surprise every idea provider equally.

#### **Record-breaking speed at Yellow Dwarf:**

Every month we report on new products here. Yellow Dwarf is one of the few providers where we run out of things to say. The speed with which we are regularly updated here is almost unbelievable.

And the hard-working 3D printer from the Czech Republic has more surprises in store for March. He is now adding a product to the waste disposal range, that is perfect for large residential units in modern housing estates: Underground containers (item no. 60008) provide above-ground disposal options for waste, which are fed into the large containers at basement level.



From now on, the "Warehouse equipment I" (item no. 60240; photo left) together with the "Shelving IV" (60245; photo right) will enrich many a haulage company, warehouse or larger commercial enterprise. Photos: Yellow Dwarf

New products for road and rail storage are designed to catch the eye: Storage equipment I (60240) is dedicated to palletised goods, while racking IV (60245) accommodates rolling tyre drums, which can also be used for direct tapping in workshops, for example.

The products are available directly from the manufacturer at <https://www.yellowdwarf.eu>.

#### The latest AZL deliveries:

New deliveries of the EMD SD70ACE were literally announced with fanfare and have now been launched. The unusual "Spirit of Union Pacific" livery variant (item no. 63109-8) on the locomotive with the road number 1943 marks the beginning.

To mark the 25th anniversary of BNSF, the GE ES64AC is now available in its anniversary livery (62415-1). The EMD SD40-2s of Canadian Pacific (64206-1 to -3) and Burlington Northern (64202-1 to -3) are rolling in three examples with the individual features of the prototypes.



The GE ES64AC (item no. 62415-1; photo left) honours the 25th anniversary of the BNSF, while the EMD SD70ACE in the special livery "Spirit of Union Pacific" (63109-8; photo right). Photos: AZL / Ztrack

The Ortner bulk freight wagons now follow in the brown Southern Pacific livery as a duo (905351-1), also available in a pack of four (905301-1). The heavy half-baggage wagon follows, running on three-axle bogies, now in the Southern version (74006-1 / -2), while the Rio Grande wide-view goods train escort

wagon (921029-1 / -2) is to run with the EMD SD40T-2 models already delivered for the same railway company.

The Trinity RAF column wagons with a prototypical length of 53 feet appear as three-part wagons with Marten trailers (905236-1), which are also available in two units each without wagons (954012-1).

The M88 armoured recovery vehicle announced in the last issue under Z tanks

is now also ready for delivery. It has an individually attached dozer blade and a movable boom. It is offered in pairs in sand colour (AZLM88-S), green (AZLM88-G) and NATO olive green (AZLM88-N).



The M88 armoured recovery vehicle is now available in three colours, shown here in NATO olive green (AZLM88-N). Photo: AZL / Ztrack

Further product images are available at <https://www.americanzline.com>.

#### Good news from Azar Models:

The Ulule financing project for the TGV was successfully completed at the end of February 2024: 140 bookings generated slightly more than the originally hoped-for EUR 100,000.00 financial boost.

This is not only a great success for French Z gauge, because so many positive and enthusiastic messages have been received that Germany's neighbouring country is apparently being completely rediscovered in its diversity and uniqueness.

Azar Models would like to thank all those involved for publicising and supporting the campaign.

This marks the start of the next adventure in mould construction, test moulds and the first samples, which are due to arrive in a few months' time and will then be presented. But in the meantime, there will also be new products and further releases.



Thanks to a successful capital collection, nothing now stands in the way of this 1:220 scale train. Photo: Falk2 (CC-BY-SA-3.0,2.5,2.0,1.0)

#### NoBa-Modelle Surprise:

NoBa-Modelle (<https://www.noba-modelle.de>) is also coming up with further new products so soon after the toy fair: The Sggmrss 90 container wagon is fitted with a Jakobs bogie and can be ordered as a finished model with containers (item no. 5330RF) and as an unfinished model (5330R) with or without containers.

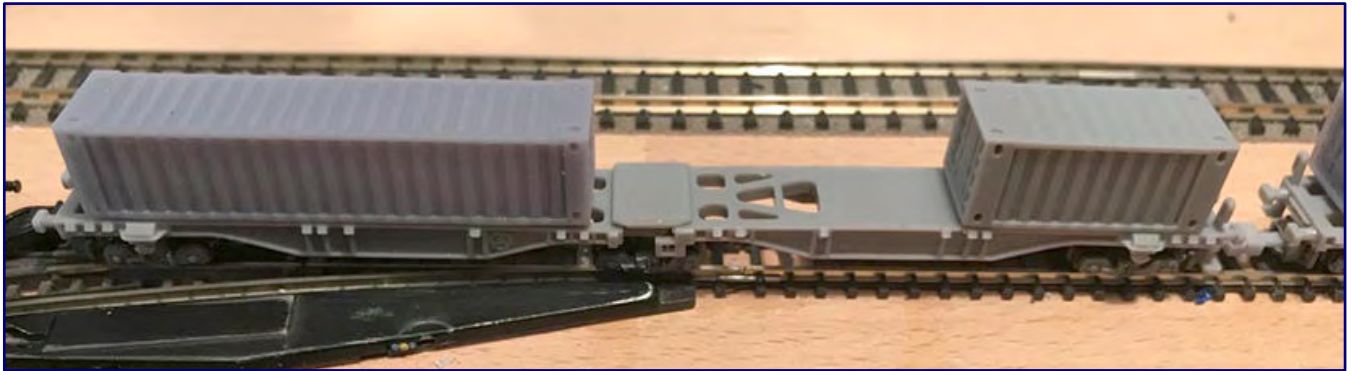

Shortly after its launch, the modern Sggmrss 90 container wagon (item no. 5330R) was given another major overhaul in the area of the central Jakobs bogie and now matches its original almost perfectly without having lost any of its running characteristics. Photo: NoBa-Modelle

It is also learning to run with shorty parts from Rokuhan: The Siemens Desiro Classic diesel multiple unit, also known as the 642 series, is also new to the range and will initially be included in the programme as a blank kit (5232R). A traffic-red finished model is to follow soon. Shortly before the editorial deadline, we were also notified of the ET 194 / LAG 895 railcar miniature as a blank (5233R) and finished model (5233RF), and it was added directly to the delivery programme.

The Mercedes-Benz NG 1632 “Auf Achse” (6926R) saw the light of day as a new truck model. The abbreviation NG once stood for “New Generation”, with which the manufacturer wanted to emphasise the replacement of its first generation of front-mounted cabs. The Freden signal box (4134R), whose brick construction is offered as a kit blank, was realised at the customer's request.



Although the NG model series has also been presented by other manufacturers, the Mercedes-Benz NG 1632 “On the road” (6926R) has never been realised in this way before. Photo: NoBa-Modelle

We also have good news for fans of the E 919, which we presented as a spring new product in the last issue: Parallel to the model, which is to run on an undestroyed crocodile chassis, Norbert Heller is currently preparing a second, strictly true-to-scale version.



One of the masterpieces so far is certainly the Freden signal box (4134R), which can be seen here already fully painted. Photo: Customer photo (NoBa-Modelle)

It will utilise what is possible on the outside, but will require cuts to the running gear parts, which can then no longer be used for the Märklin Crocodile. At the time of going to press, the couplings had not yet been finalised: If possible, an option should be found here that also allows shunting with uncouplers from the Jörger system.

#### A delivery at MTL:

In the month under review, we were only informed of a single delivery at Micro-Trains (<https://www.micro-trains.com>). This is a covered 36-foot heat protection wagon with wooden walls, built in 1928 (item no. 518 00 863). It was employed by P&E for Nye & Nissen, who used it to transport eggs, butter, and cheese. This is why the yellow wagon also carries a self-advertisement for eggs.

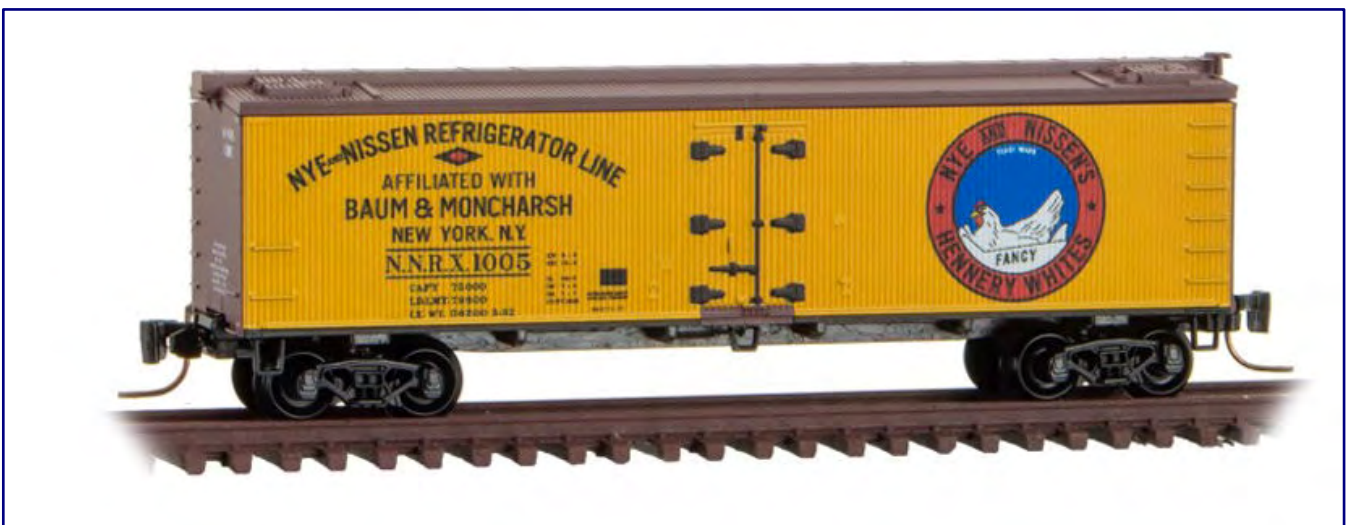

The original of this insulated trolley (item no. 518 00 863) dates back to 1928 and was used to transport food. Photo: Micro-Trains

**Successful film release:**

The film "Wunderland" reviewed in this issue got off to a successful start. As the best newcomer, it has reached third place in the German cinema charts and is now on a par with many a box office hit from Hollywood. This certainly underlines the positive impressions that we have summarised in this issue.



In many film scenes, the Braun brothers appear as animated figures in childhood on their large exhibition layout to tell the story of their dream come true. Photo: TOBIS Film GmbH

On 25 April, the Monaco section, including the Formula 1 race and adjoining Provence, will be opened in Hamburg. From the following day, this section will also be open to the public.

**Deliveries at Märklin complete the trio:**

Märklin recently delivered the old construction tank car with brakeman's cab (item no. 80324), used by the BV-Aral on the German Federal Railroad. It is the latest car in a series with some differences, which now forms a trio worth seeing.



This Aral tank wagon (item no. 82304) together with its two predecessors now forms a handsome trio.

A little later, the "Bosporus Sprinter" also arrived at the dealers. This is a Siemens ES 64 U2 locomotive from MRCE Dispolok GmbH (88588) for Era VI.

The black locomotive from the Taurus family has three single-arm pantographs, of which the two outer ones are electrically functional.

The latest delivery in the form of a train set with a Railbouw Leerdam V 36 diesel locomotive (81771) is already sold out at the factory. The locomotive is

supplemented by three rotary slide side unloading wagons, is located in Era IV and was at home in the Netherlands as a prototype.

With the “Hanau temporary signal box” kit (89808), a spring 2024 new product has also already been delivered. When assembled, the solid-coloured hard cardboard parts result in a coach body of the MCI temporary passenger coach placed on a wall base, as it served as a temporary solution in the Hanau main station area.

#### Early pioneers of the lightweight:

This month, WDW Full Throttle is commemorating an interesting chapter in railway history. In the early years of the 20th century, a new material, aluminium, was introduced to railway vehicle manufacturers in the USA. From 1931, the lightweight and corrosion-resistant metal also found its way into wagon construction.

The idea behind this was to be able to significantly increase the load weight with less dead weight of a wagon with the same box dimensions. The trials were only interrupted by the Second World War. Two railway companies started the practical trials: the Southern (SOU) and the Chicago, Burlington and Quincy Railroad (CBQ).



With a new double pack, WDW Full Throttle is showcasing two early bulk goods wagons (item no. FT-COL67) made of lightweight aluminium construction. Photo: WDW Full Throttle

The new collector's pack (item no. FT-COL67) with one such 33-foot bulk goods wagon from each of the two companies takes up the memory of this pioneering era. The models are painted aluminium-coloured, have external box struts, two outlet openings on the wagon floor, in-house couplings, bogies, and wheelsets.

#### Just announced, already available:

Artitec has already completed the first two deliveries just over a month after announcing its new spring 2024 figures. Two packs from the new figure range have already been delivered, which we want to present in more detail in a separate figure article in the near future.



The new bricklayers (item no. 52.0001; photo above) as well as the field farmers (522.0003; photo below) also stand up to critical scrutiny when enlarged several times without revealing any flaws. Worth seeing are details such as the wooden shoes on the farmer's wife's feet, which used to be common in the countryside.

The bricklayers (item no. 52.0001) and the farmers (522.0003) are now available from dealers. The new figures have been produced using a mixed construction method of plastic and etched parts (farmers' baskets), underlined by a perfect application of colour. Details such as facial features and folds in the clothing only really become visible in macro shots.

We are therefore also very excited about the further realisations, as the impression of these completely new products for our scale is at the usual high level of the Dutch specialist. The perfect detailing makes the new figures very interesting for detailed scenes in the foreground, where the observer can still perceive them.



## Imprint

ISSN 2512-8035

Bibliographic information of the German National Library: The German National Library lists this publication in the German National Bibliography. Detailed bibliographical data and editions can be found in the DNB catalogue at <https://portal.dnb.de>.

The publication of **Trainini German Magazine for Z Gauge** is voluntary and non-commercial. **Trainini German Magazine for Z Gauge** does not aim for any sources of income. This publication is governed exclusively by German law.

Contributions marked by name exclusively reflect the personal opinion of the author. This is not necessarily the same as that of the editor or publisher. Unless otherwise indicated, photos are taken by the editor.

Board of Editors:  
Holger Späing (Editor-in-Chief)  
Harald Fried  
Ralf Junius  
Dirk Kuhlmann  
Joachim Ritter

Correspondent North America:  
Robert J. Kluz

English translation:  
Alexander Hock, Christoph Maier, Oleksiy Mark, Martin Stercken

Further voluntary work: Stephan Fuchs, Torsten Schubert

Licensed **Trainini Discussion Group** (<https://www.facebook.com/groups/1597746057122056/>): Michael Etz (**Trainini Locomotive Doctor**)

Publisher and Responsible in terms of German press law (V.i.S.d.P.) is Holger Späing, Am Rondell 119, 44319 Dortmund; Contact: 49 (0)231 9598 7867 or by e-mail to [redaktion\[at\]trainini.de](mailto:redaktion[at]trainini.de).

Advertisements of events and advertisements of third parties are free of charge, but will only be accepted after availability and recognisable Z gauge reference. They appear separately from the editorial part on the sole responsibility of the advertiser. Advertisements from small series providers always have priority.

Letters to the editor must be submitted in writing by post or e-mail to [leserbriefe\[at\]trainini.de](mailto:leserbriefe[at]trainini.de), stating the full name and address of the responsible reader, and are always welcome. Publication is reserved to the editorial staff. The editorial team always endeavours to present a representative picture and therefore to take every submission into account.

By submitting video clips, pictures, photos and drawings, the sender agrees to the publication and indemnifies the publisher against any possible claims by third parties. This expressly includes a future repetition in the magazine, **Trainini TV** as well as in brochures and posters.

All company names, trademarks and designations mentioned in this publication belong to the respective manufacturers or rights owners. Their reproduction takes place without guarantee of the free usability. For misprints, errors, price quotations, product descriptions, building specifications or transmission errors of any form whatsoever, the editorial staff and publisher assume no liability.

**Trainini German Magazine for Z Gauge** is published monthly (without guarantee) and is available to all interested model railroaders, especially fans of Z gauge, to download free of charge and for a limited time from <https://www.trainini.eu>. Downloading may incur third-party connection and network service provider costs. The placement of only the complete magazine on other domains is expressly permitted after it is no longer available on **Trainini's** own webpages, and as long as the download is not offered for a fee. **Trainini TV** can be found at <https://www.youtube.com/TraininiTV>.

All contributions, videos, photos and reports are subject to copyright. Translation, commercial printing and any other form of reproduction, even in part, require the prior express consent of the publisher. Unauthorized commercial use will not be tolerated.

**Trainini®** is a legally protected trademark, registered in the register of the German Patent and Trademark Office (Munich), No. 307 30 512. The trademark is owned by Holger Späing, Dortmund. Misuse will not be tolerated. All rights reserved.